

DATED

6th February

2024

SUFFOLK COUNTY COUNCIL

(1)

- and -

BENNETT PLC

(2)

AGREEMENT

made pursuant to Sections 278 and 38 of the Highways Act 1980
and any other enabling power relating to
the development of land on the west side of Station Terrace, Framlingham, Suffolk
and on the south side of Clarke Drive, Framlingham, Woodbridge, Suffolk

Nigel Inniss
Head of Governance
Suffolk County Council
8 Russell Road Ipswich
Suffolk IP1 2BX

Ref: AS/80229/LEGAL

**SECTION 278 AGREEMENT
INDEX**

	Page
Recitals & Definitions	
RECITALS AND DEFINITIONS.....	4
1 LEGAL EFFECT	9
2 NOTICES	9
3 GENERAL.....	10
4 ARBITRATION	11
5 COVENANTS.....	12
1 THE DESIGN OF THE HIGHWAY WORKS	15
2 LETTING OF THE CONTRACT.....	16
3 INSPECTION OF THE HIGHWAY WORKS	17
4 TESTING OF MATERIALS.....	18
5 OPENING OF THE HIGHWAY WORKS.....	19
6 UNDERTAKERS.....	20
7 PROTECTION OF THE PUBLIC	21
10 TIMING.....	23
11 SAFETY	23
12 ACCOMMODATION WORKS	24
13 CONSTRUCTION (DESIGN AND MANAGEMENT) REGULATIONS 2015.....	24
14 SITE CLEARANCE AND CERTIFICATE(S) OF SUBSTANTIAL COMPLETION	26
15 DEFECTS CORRECTION PERIOD AND CERTIFICATE OF FINAL COMPLETION	26

16	INDEMNITY	28
17	PERFORMANCE BOND.....	29
18	COMMUTED SUMS FOR MAINTENANCE.....	30
19	LEGAL AND ADMINISTRATIVE COSTS.....	30
20	PARTS I AND II OF THE LAND COMPENSATION ACT 1973.....	31
	SCHEDULE II.A.....	33
	SCHEDULE II.B <i>Not Used</i>	37
	SCHEDULE III	38
	SCHEDULE IV.....	39

THIS AGREEMENT is made the 6th day of February 20 24
BETWEEN the following parties :-

- (1) **SUFFOLK COUNTY COUNCIL** of Endeavour House 8 Russell Road Ipswich
Suffolk IP1 2BX ("the County Council")
- (2) **BENNETT PLC** (company number 01031743) of Low Green Barn, Nowton,
Bury St Edmunds, Suffolk, IP29 5ND ("the Developer")
- (3)

RECITALS AND DEFINITIONS

(A) In this Agreement unless the context otherwise requires the following words shall have the following meanings :-

"1980 Act"	Means the Highways Act 1980 (as amended)
"Approved Contractor"	Means the contractor(s) approved by the County Council for carrying out the Highway Works of the value and complexity proposed
"Approved Sub-Contractor"	Means the sub-contractor(s) approved by the County Council for carrying out the Highway Works of the value and complexity proposed
"CDM Regulations"	Means the Construction (Design and Management) Regulations 2015 (SI 2015/51)
"Certificate of Final Completion"	Means any of the certificates referred to in paragraph 15.3 of Schedule I
"Certificate of Substantial Completion"	Means any of the certificates referred to in paragraph 14.2 of Schedule I
"Committed Sums"	Means the sum of £26,230.83 (Twenty-Six Thousand, Two Hundred and Thirty Pounds and Eighty-Three Pence) which is calculated, as set out in paragraph 18.1 on Schedule I towards the cost of the County Council's future maintenance liability of the Highway Works

“Contract”	Means the contract or contracts in respect of each and all of the Highway Works
“Contractor”	Means the contractor or contractors who have been awarded the Contract to execute the Highway Works. For the avoidance of doubt the aforementioned definition does not include any subcontractor
“Development”	Means the development to be carried out pursuant to the Permission
“Director”	Means the County Council’s Executive Director of Growth, Highways and Infrastructure or other officers of the County Council acting under his hand
“Highway Works”	Means the works collectively or individually as the context requires which are set out in Schedule III of this Agreement and shown in the Works Drawings
“Highway Structure”	Means any bridge, subway, culvert, pipe, tunnel, or other structure built in, over, under or adjacent to any part of the highway
“Performance Bond”	Means the bond with the Performance Bond Surety for each and all of the Highway Works, such bond to be in the form set out in Schedule II.A, to the effect that should the Developer default in the execution of its obligations to carry out the Highway Works and to maintain the same in accordance with the provisions of this Agreement then the County Council will call upon the Performance Bond Surety to provide the full value of the Performance Bond (subject to the provisions hereinafter contained) to carry out the Highway Works and maintain the same as aforesaid
“Performance Figure”	Means the sum of £117,649.69 (One Hundred and Seventeen Thousand, Six Hundred and Forty-Nine Pounds and Sixty-Nine Pence) being the Tender Sum plus 10 per cent in respect of the Highway Works and as set out in each of the Contracts

“Performance Bond Surety”	Means National House Building-Council
“Permission”	Means the outline planning permission granted by East Suffolk Council dated 13 November 2020 granted with reference number DC/20/2356/OUT and reserved matters approval granted with reference number DC/22/4727/ARM in respect of the Site together with any modification of it
“Road Safety Audit”	Means the evaluation of each and all of the Highway Works during design and at the end of construction to identify potential road safety problems that may affect any users of the highway and to suggest measures to eliminate or mitigate those problems in accordance with Department for Transport standards or by the County Council as agreed by the Director
“Site”	Means land situated on the west side of Station Terrace, Framlingham Suffolk and land on the south side of Clarke Drive, Framlingham, Woodbridge, Suffolk shown edged black for identification only on the attached plan no 2210-754 278D
“Specification”	The County Council’s “Specification for Estate Roads” dated May 2007 (or later amendment current at the date of this Agreement) so far as this is consistent with the Works Drawings and description in Schedule III (subject to any variations agreed in writing by the Director)
“Sub-contractor”	Means the sub-contractor(s) working for the Contractor(s) who have been contracted to execute the Highway Works
“Substantial Completion”	Means complete to the reasonable satisfaction of the Director and so that the Highway Works can be used for the purpose and operate in the manner for which they were designed
“Technical Standards”	Means the standards necessary to ensure complete conformity with all UK primary and secondary legislation (including by-laws) all guidance standards and codes of practice issued by the Department for Transport the County Council statutory undertakers and relevant professional

institutes the Road Safety Audit and formal instructions issued by the Director from time to time during the design and implementation of the Highway Works and for the avoidance of doubt this shall include the Traffic Signs Regulations and General Directions 2016 and BS5489 in relation to the design of any street lighting

"Tender Sum" Means the sum of £106,954.27(One Hundred and Six Thousand, Nine Hundred and Fifty Four Pounds and Twenty Seven Pence) (including the costs associated with statutory undertakers work and traffic management) agreed by the Director for carrying out the Contract by the Contractor

"Works Drawings" Means the attached drawings bearing the numbers referred to in Schedule IV or any subsequent revision of them which has been approved or requested by the Director and which relate to the Highway Works

- (B) In this Agreement unless the context otherwise requires :-
- (i) Words importing the singular meaning where the context so admits include the plural meaning and vice versa; and
 - (ii) Words of the masculine gender include the feminine and neuter genders and words denoting actual persons include companies, corporations and firms and all such words shall be construed interchangeably in that manner; and
 - (iii) "party" or "parties" means a party or parties to this Agreement; and
 - (iv) references to any party shall include the successors in title and assigns of that party; and in the case of the County Council the successors to its statutory functions; and
 - (v) where a party includes more than one person any obligations of that party can be enforced against all of them jointly and severally unless there is an express provision otherwise; and
 - (vi) the headings and contents list in this Agreement shall not form part of or affect its construction; and

- (vii) references to clauses schedules and paragraphs are references to clauses in and schedules to this Agreement and paragraphs in schedules to this Agreement; and
 - (viii) where a party or any officer or employee is required to give its consent approval or agreement to any specific provision in this Agreement such consent approval or agreement shall not be unreasonably withheld or delayed; and
 - (ix) any mention herein of any act or of any section regulation or statutory instrument shall be deemed to refer to the same source as at any time amended and where such act section regulation or statutory instrument has been replaced consolidated or re-enacted with or without amendment such mention shall be deemed to refer to the relevant provision of the updating consolidating or re-enacting act or section or regulation or statutory instrument
- (C) The County Council is the highway authority (except for trunk roads) for the purposes of the 1980 Act for the area within which the Site is situated and the Highway Works will be carried out
- (D) The Developer has the benefit of the Permission
- (E) The Developer is the registered proprietor with title absolute of the Site in so far as it is registered at the Land Registry under Title Number SK229608 and SK419062
- (F) The Developer wishes to dedicate as public highway that part of the Site upon which the Highway Works are to be constructed which does not currently form part of the public highway and the County Council agrees to accept such dedication and adopt that part of the Site and the Highway Works as highway maintainable at public expense on the terms and conditions hereinafter contained
- (G) Having regard to the development plan and other material considerations the County Council considers it expedient in the interests of the proper planning of their area that the Highway Works need to be carried out to facilitate the Development and that entering into this Agreement will be of benefit to the public

NOW THIS DEED WITNESSES as follows:-

1 LEGAL EFFECT

- 1.1. This Agreement and the covenants that appear hereinafter are made pursuant to Sections 38 72 and 278 of the 1980 Act Section 111 of the Local Government Act 1972 and Section 1 of the Localism Act 2011 and all other enabling powers to the intent that the provisions of this Agreement shall bind the Site and the parties hereto and all persons deriving title through or under them
- 1.2. This Agreement is a Deed. Any financial default under this Agreement will be registered as a Local Land Charge under section 278(5)(c) of the 1980 Act
- 1.3. No waiver (whether express or implied) by the County Council of any breach or default by the Developer in the performance or observance of any of the covenants, terms or obligations in this Agreement shall constitute a continuing waiver and no such waiver shall prevent the County Council from enforcing any of the covenants, terms or obligations or from acting upon any subsequent breach or default in respect thereof
- 1.4. Any provision of this Agreement which is or may be unlawful void or unenforceable shall to the extent of such unlawfulness invalidity or unenforceability be deemed severable and shall not affect any other provision of this Agreement
- 1.5. This Agreement is governed by and interpreted in accordance with English law and shall be determined in the Courts of England

2 NOTICES

- 2.1. Any notices or other written communication to be served or given by one party upon or to any other party under the terms of this Agreement shall be deemed to have been validly served or given if delivered by hand or sent by recorded delivery post or sent by the DX service to the party upon whom it is to be served or to whom it is to be given or as otherwise notified for the purpose by notice in writing provided that the notice or other written communication is addressed and delivered by

hand or by recorded delivery post or by the DX service to the address of the party concerned as nominated in sub-clause 2.2. below

- 2.2. The address for any notice or other written communication in the case of each party to this Agreement shall be as follows:-

The County Council Suffolk County Council Endeavour
House 8 Russell Road Ipswich IP1
2BX marked for the attention of the
Assistant Director of Governance,
Legal and Assurance (or where the
context requires the Executive
Director of Growth, Highways and
Infrastructure, Endeavour House 8
Russell Road Ipswich IP1 2BX)

The Developer marked for the attention of the
Development Director, Bennett plc,
Low Green Barn, Nowton, Bury St
Edmunds, Suffolk IP29 5ND

- 2.3. Any notice or other written communication to be given by the County Council shall be deemed to be valid and effective if on its face it is signed on behalf of the County Council by a duly authorised officer

3 GENERAL

- 3.1. All works and activities to be carried out under the terms of this Agreement (including for the avoidance of doubt such works as are of a preparatory ancillary or of a maintenance nature) are (save where expressly provided otherwise) to be at the sole expense of the Developer and at no cost to the County Council
- 3.2. All consideration given and payments made in accordance with the provisions of this Agreement shall be exclusive of any VAT properly payable in respect thereof and in the event of VAT becoming chargeable at any time in respect of any supply made in accordance with the terms of this Agreement then to the extent that VAT had not previously been charged in respect of that supply the person making

the supply shall raise a VAT invoice to the person to whom the supply was made and the VAT shall be paid accordingly

- 3.3. The County Council and their respectively duly authorised officers and agents may enter upon the land on which the Highway Works are being carried out at any reasonable time to ascertain whether the terms of the Agreement are being or have been complied with

4 ARBITRATION

- 4.1. Any dispute or difference arising between the parties as a result of this Agreement may be referred to the arbitration of a single arbitrator to be agreed upon between the parties or failing agreement within fourteen days after either of the parties has given to the other a written request requiring the appointment of an arbitrator to a person to be appointed at the request of either of the parties by the President for the time being of The Institution of Civil Engineers
- 4.2. Any reference to arbitration shall be undertaken in accordance with and subject to the provisions of the Arbitration Act 1996 save as follows:-
 - (a) the seat of the arbitration shall be at the County Council's offices in Ipswich Suffolk
 - (b) where appropriate the arbitrator may consolidate arbitral proceedings
 - (c) with the parties' agreement the arbitrator may appoint experts or legal advisers
- 4.3 A party wishing to refer any such dispute or difference to arbitration shall notify the other party in writing of such intention without delay
- 4.4 The arbitrator shall act as a referee and not as an expert except in any case where the parties to a dispute or difference agree on the arbitrator when such parties may also agree that such arbitrator shall act as an expert
- 4.5 Subject to Sections 67 68 and 69 of the Arbitration Act 1996 the parties agree to be bound by the decision of the arbitrator

5 COVENANTS

- 5.1 The Developer covenants and warrants to the County Council that they have full power to enter into this Agreement and there is no other person having a charge over or any other interest in the Site whose consent is necessary for the Developer to enter into this Agreement and to comply with the obligations set out at paragraph 14.3 of Schedule I
- 5.2 The Developer hereby covenants and undertakes with the County Council that from the date of this Agreement it will (unless otherwise agreed by the County Council) carry out and comply with the obligations set out in Schedule I and the details set out in Schedules III and IV hereto
- 5.3 The County Council without prejudice to its statutory powers and duties hereby appoints the Developer to act as its agent and gives to the Developer licence (in so far as is reasonably necessary for the Developer to perform the obligations under the terms of this Agreement) to enter into and upon and remain upon the highway to carry out the construction of the Highway Works within the timescales referred to in Schedule III hereto or such other period as may be agreed in writing by the Director, provided that this licence shall not extend to the Developer's successors in title or assigns unless otherwise agreed in writing by the Director prior to that successor or assignee commencing work in the public highway
- 5.4 The Developer covenants with the County Council not to commence the Highway Works set out in Schedule III unless road space has first been booked with the County Council
- 5.5 The Developer covenants with the County Council as highway authority to give written notice not less than three calendar months prior to works commencing, in order that the County Council as highway authority has sufficient time to ensure that the commencement of works will cause the least disruption possible to road users and the County Council reserves the right to refuse consent and/or to stop or require the stopping of works under the terms of this Agreement and relevant legislation where the aforesaid notice period is not complied with
- 5.6 The Developer covenants with the County Council as highways authority to comply with the provisions of the New Roads and Street Works Act 1991, the Traffic Management Act 2004 and any amendments thereof

5.7 The County Council covenants with the Developer that on the date of issue of the Certificate of Final Completion the roads subject to the Highway Works shall thenceforth be, to the extent they are not already, adopted as highways maintainable at the public expense

6 THIRD PARTY RIGHTS

6.1 It is hereby agreed and declared that the provisions of Contracts (Rights of Third Parties) Act 1999 shall not apply to this Agreement

7 LAPSE

7.1 If the Highway Works have not been commenced within one (1) year from the date of this Agreement, save as this period is otherwise extended in writing by the Director at his discretion, then this Agreement shall lapse and be of no further effect (save to the extent already complied with) and the Developer agrees to pay to the County Council any costs properly incurred by the County Council prior to the lapse of this Agreement (which have not already been paid) including but not limited to those costs set out in paragraph 19 of Schedule I to this Agreement

7.2 Where, in accordance with clause 7.1 above the Director, at his discretion, agrees in writing to an extension to the period of one (1) year after which this Agreement shall lapse, this Agreement shall lapse at the end of such period as agreed in writing by the Director where the Highway Works have not been commenced by the expiry of that extension period

In witness whereof this Agreement has been executed and delivered as a Deed on the date first written above

The COMMON SEAL of)
SUFFOLK COUNTY COUNCIL)
was hereunto affixed)
in the presence of)

13

*a duly authorized officer -
N. M. G. M. M. M.*



in overleaf
A Duly Authorised Officer

Executed as a deed by BENNETT PLC)

acting by EDWARD PARKER, a director and)

ADAM BELL, a director OR secretary)



Director



Director/Secretary

SCHEDULE I

1 THE DESIGN OF THE HIGHWAY WORKS

- 1.1 The design of the Highway Works shall be to the satisfaction of the Director with due consideration of the Technical Standards
- 1.2 No work on any of the Highway Works shall commence and no Contract for their construction shall be let until
 - 1.2.1 full details of the design of the Highway Works to be commenced in the form of plans, drawings, specifications and other materials have been submitted to the Director together with the name of the principal designer (whom the Developer shall appoint for the full duration of the design and construction of each and all of the Highway Works) in accordance with the CDM Regulations and any codes of practice referred to therein
 - 1.2.2 the Director has given his written approval to the Highway Works to be commenced and such approval shall not be given if the said plans, drawings, specifications and other documentation have not adequately addressed the issues raised in the pre-construction stages of the Road Safety Audit process and if given shall lapse if the Highway Works are not commenced within twelve (12) months of the date of the said Director's approval
 - 1.2.3 preliminary proposals, detailed contract drawings, schedules and specifications for Highway Structures have been prepared by the Developer and submitted for written approval to the Director's Bridge Office in accordance with Department for Transport Document BD2/12 and the structural design and checking procedure has been carried out by an incorporated or chartered engineer familiar with Department for Transport Codes of Practice and experienced in the design of Highways Structures. The documents are to be agreed as applicable with the Director before the design is commenced and details are submitted for approval

- 1.3 If the Director does not propose to give his approval in relation to those matters referred to in paragraph 1.2 of this Schedule he shall in each case as soon as possible in writing inform the Developer and if the Director requires amendments or additions to the plans drawings specifications and other materials referred to in paragraph 1.2 of this Schedule these amendments shall be undertaken by the Developer at his own expense and a revised set of updated documents shall be re-submitted to the Director for his approval
- 1.4 Without prejudice to paragraph 1.2 of this Schedule, the Director shall not give his approval as referred therein until the Developer has paid the sum referred to in paragraph 19.1.3 towards the cost of checking the design of the Highway Works and inspecting the Highway Works. The Highway Works at all times shall be carried out in accordance with the plans, drawings, specifications and other materials which have received the Director's approval referred to in paragraph 1.2 of this Schedule and the Developer shall in the execution of the Highway Works comply or ensure that the Contractor complies with the Technical Standards

2 LETTING OF THE CONTRACT

- 2.1 No Contract shall be let until all traffic management measures have been prepared by the Developer and approved in writing by the Director ("the approved programme") and thereafter each of the Contracts will be offered to an Approved Contractor
- 2.2 The Contract to be let under paragraph 2.1 of this Schedule shall be let under NEC3 suite of contracts (and any amendments thereto shall be approved by the Director) and the Developer shall obtain the agreement of the Contractor to be bound by the agreed drawings in Schedule IV
- 2.3 The Contract shall be awarded by the Developer subject to the Director having first given his written approval to the proposed chartered engineer(s) or other suitably qualified person(s) who shall be independent of the Contractor and will supervise the execution of the Highway Works by the Contractor
- 2.4 The Developer shall not award the Contract unless the Approved Contractor and the Approved Sub-Contractor/s concerned are insured throughout the period of the Contract (such period to include the

maintenance period detailed in paragraph 15.1 of this Schedule) for public liability risks in the sum of at least ten million pounds (£10,000,000) in respect of any single claim and the Developer shall ensure that the Contractor remains so insured throughout the period of the Contract and prior to the commencement of each or all of the Highway Works or any maintenance works carried out in accordance with paragraph 15.1 of this Schedule the Developer shall produce to the Director insurance policies fully covering the Developer's liability in respect of the matters set out in this Agreement

- 2.5 The Developer shall not sub-contract or assign the Contract without the written approval of the Director and any sub-contractor shall be an Approved Sub-Contractor

3 INSPECTION OF THE HIGHWAY WORKS

- 3.1 The Developer shall provide the Director with not less than twenty-four (24) hours nor more than seventy-two (72) hours notice (excluding weekends and bank holidays) of any intended execution of the Highway Works specifying the tasks to be carried out in accordance with the approved programme referred to in paragraph 2.1 of this Schedule
- 3.2 Without prejudice to the approved programme the Developer shall notify the Director in writing at least twenty-eight (28) days prior to the commencement of any work connected with statutory undertaker's equipment
- 3.3 Without prejudice to the approved programme the Developer shall notify the Bridge Office and the Director in writing at least seventy-two (72) hours prior to the commencement of each and every stage of excavation and concrete operations associated with any Highway Structures
- 3.4 The Developer shall during the progress of each and all of the Highway Works give to or procure for the Director and any person or persons duly authorised by him free access to every part of the Highway Works and the Site and permit him or them to inspect the same as they proceed and all materials used or intended to be used therein and shall give effect to any reasonable and proper requirements made or reasonable and proper directions given by the Director to conform to the approved detailed plans

Works Drawings and specification referred to in paragraph 1.2 of this Schedule

- 3.5 The Developer shall not cover up or put out of view any works forming part of the Highway Works without the approval of the Director and shall afford full opportunity for the Director to examine and measure any work which is about to be covered up or put out of view and to examine foundations before permanent work is placed thereon and shall give at least seventy-two (72) hours' notice to the Director whenever any such work or foundations is or are ready or about to be ready for examination
- 3.6 The Director shall without unreasonable delay, unless she considers it unnecessary and advises the Developer accordingly, attend when required by the Developer for the purpose of examining such works or of examining such foundations
- 3.7 The Director shall for the purposes of paragraphs 3.1 to 3.6 be allowed reasonable access and admission to the Highway Works or the places where materials or plant for the Highway Works may be stored or in the course of preparation manufacture or use (unless such access or admission is refused due to circumstances beyond the control of the Developer)

4 TESTING OF MATERIALS

- 4.1 The Developer shall reimburse the County Council for all reasonable costs and expenses whatsoever arising from the operation of paragraphs 4.2 to 4.5
- 4.2 The Director shall require the testing of materials plant and workmanship used or proposed to be used in the Highway Works and in his reasonable discretion have the power to reject any materials plant or workmanship so tested which he may reasonably and properly find to be not in accordance with the approved detailed plans Works Drawings and specification referred to in paragraph 1.2 of this Schedule In relation to Highways Structures the Director will require a schedule of testing to be agreed prior to the commencement of works or any part thereof
- 4.3 The Developer shall as soon as is reasonably practicable replace or repair any materials plant or workmanship which have been found to be

not in accordance with the approved detailed plans Works Drawings and specification referred to in paragraph 1.2 of this Schedule

- 4.4 The Director shall for the purposes of paragraphs 4.2 to 4.5 be allowed reasonable access and admission to the Highway Works or the places where materials or plant for the Highway Works may be stored or in the course of preparation manufacture or use (unless such access or admission is refused due to circumstances beyond the control of the Developer)
- 4.5 The Developer shall as soon as is reasonably practicable remove such materials and plant as are rejected by the Director pursuant to paragraph 4.2. of this Schedule which are not capable of repair or remedy from the Site and if the Developer shall wish to continue to store such rejected materials and plant on the Site they shall be stored separately from those materials and plant which have not been so rejected or which the Developer shall wish in future to use in execution of the Highway Works

5 OPENING OF THE HIGHWAY WORKS

- 5.1 During the construction of each and all of the Highway Works and prior to the issue of the Certificate of Substantial Completion:
- (a) the Director may issue instructions to the Developer to open or expose any of the Highway Works which has been covered up without previously being inspected by the Director
 - (b) should the Developer fail to comply with any such instructions the County Council may so take up or expose the relevant part of the Highway Works causing as little damage or inconvenience as is possible in respect of any other part or parts of the Highway Works the reasonable and proper cost of such taking up or exposure and reinstatement to be met by the Developer

PROVIDED THAT if the Highway Works or any part or parts thereof are covered up by the Developer after giving the notice referred to in paragraph 3.5 of this Schedule and the Director shall have failed to inspect in the period therein referred to and the Director shall subsequently require the Highway Works or any part of them to be uncovered for the purposes of inspection:-

- (a) if inspection reveals the relevant part or parts of the Highway Works to have been completed in accordance with the approved detailed plans drawings and specification referred to in paragraph 1.2 of this Schedule all costs in respect of such uncovering and inspection and of reinstating the part or parts of the Highway Works uncovered shall be borne by the County Council; or
- (b) if inspection reveals the relevant part or parts of the Highway Works not to have been completed in accordance with the approved detailed plans drawings and specifications referred to in paragraph 1.2 of this Schedule all reasonable and proper costs in respect of uncovering and inspection and of reinstating the part or parts of the Highway Works uncovered shall be borne by the Developer

6 UNDERTAKERS

6.1 Insofar as the County Council as Highway Authority is required by any legislation regulation direction or code of practice (including in particular but without prejudice to the generality of the foregoing the New Roads and Street Works Act 1991) to serve a notice or notices in respect of the Highway Works on undertakers or other persons the Developer shall comply with such requirement on behalf of the County Council before the Highway Works commence and shall thereafter assume on behalf of the County Council such responsibilities as follow on therefrom in particular during the construction of the Highway Works and prior to the issue of the Certificate of Substantial Completion the Developer shall also:-

- (a) carry out or procure the carrying out of such works and activities in regard to the plant and equipment of undertakers as are required by undertakers in accordance with their statutory powers under the New Roads and Street Works Act 1991 as a result of the construction or intended construction of each and all of the Highway Works
- (b) cause all public sewers, highway drains gas and water mains electric cables and telecommunications ducts or other apparatus which are to be laid by the Developer under the Highway Works together with all necessary connections from them to the boundary of the Highway Works to be laid so far as is practicable under the

Highway Works before the foundation of the Highway Works are laid and shall also in so far as is practicable cause the connections from electric cables to any street lamp to be laid before the paving of the footways comprised in the Highway Works is carried out

- (c) cause all trench works within the highway to be backfilled and reinstated in accordance with the Specification for the Reinstatement of Openings in the Highway as determined from time to time under the New Roads and Street Works Act 1991
- (d) not at any time give consent to the erection by any telecommunications operator of telegraph poles or telephone poles or to the erection by any statutory undertaker or public or private company firm or individual of any over ground or underground equipment without the consent in writing of the Director

7 PROTECTION OF THE PUBLIC

- 7.1 The Developer shall give due consideration to adjoining owners and occupiers at all times and shall organise activities relating to the Highway Works in such a manner as to cause the least practicable disruption
- 7.2 Prominent notices shall be displayed and maintained around the perimeter of the site of each and all of the Highway Works to warn the public of the dangers of entering the Site
- 7.3 The Developer shall nominate a member of the site management team as the contact point for the Director in the event of an emergency and shall advise a daytime and twenty-four (24) hour contact number to the Director for the same purpose
- 7.4 The Developer shall take or procure the taking of all necessary steps to avoid creating a nuisance from noise and in particular:
 - 7.4.1 the Developer shall afford all reasonable facilities to enable the Director to carry out such site investigations as she may deem necessary in order to determine noise emission levels
 - 7.4.2 all vehicles and plant including compressors shall be fitted with effective silencers and acoustic covers as appropriate and maintained in good working order and all static plant shall be

located to minimise nuisance to persons living or working in the vicinity

7.4.3 all portable traffic signals and pumps shall be operated from mains electricity unless otherwise agreed with the Director

7.4.4 noisy activities shall not be permitted on Sundays and Bank Holidays and except as agreed in writing by the Director shall not be permitted outside the hours of 9.30 a.m. to 4.30 p.m. Monday to Friday and 9.30 a.m. to 1 p.m. on Saturdays

PROVIDED THAT if in the reasonable opinion of the Director the Developer is not dealing adequately with the control of noise the Developer shall carry out or procure the carrying out of such additional measures as the Director considers necessary at the Developer's expense

7.5 Compliance with the provisions of paragraph 7.4 shall not relieve the Developer of any of his obligations and liabilities under this Agreement the Control of Pollution Act 1974 or the Environmental Protection Act 1990

7.6 The Developer shall take or procure the taking of all necessary steps to avoid creating a nuisance from dust and as far as practicable works are to be carried out in such a way that dust is kept to a minimum PROVIDED THAT if in the reasonable opinion of the Director the Developer is not dealing adequately with the control of dust the Developer shall carry out or procure the carrying out of such additional measures as the Director considers necessary at the Developer's expense

7.7 The Developer shall arrange the regular removal of refuse likely to encourage vermin and arrange for suitable secure storage containers to be provided for collection

7.8 The Developer shall keep a log book on site to record all complaints received from the public and the action taken in response and the log book shall be available for inspection by the Director

8 PREVENTION OF MUD BEING CARRIED ON THE PUBLIC HIGHWAY

- 8.1 Provision shall be made at the Site to limit in so far as is practicable the amount of mud dust and other materials carried on to adjacent public highways by vehicles and plant leaving the Site
- 8.2 The Developer shall keep or procure the keeping of all roads footpaths rights of way and other means of passage leading to or from or crossing the Site free from mud slurry or other hazardous substances that are deposited through the construction of the Highway Works and any such substance so deposited on any such road footpath right of way or other means of passage shall be promptly removed by or at the direction of the Developer
- 8.3 The Director may close any associated crossings entrances and exits if such substances deposited are not promptly removed by the Developer and any losses or expenses incurred as a result shall be borne by the Developer and on removal of such substances the Director shall reopen such crossings entrances and exits and the Developer shall bear the costs incurred

9 TRAFFIC CONTROL

- 9.1 During the periods when the Highway Works are being executed the Developer shall institute at his own expense measures previously approved in writing by the Director to maintain the safe flow of traffic on the highways in the vicinity of the site of the Highway Works
- 9.2 The Highway Works shall be signed and protected to at least the standards of Chapter 8 of the Traffic Signs Manual published by His Majesty's Stationery Office and the proposed arrangements shall be approved in writing by the Director before the Highway Works commence

10 TIMING

- 10.1 No Highway Works within or affecting existing public highways or temporary diversions which could interfere with the traffic flow will be permitted within the morning and evening peak periods i.e. 7.30 - 9.30 a.m. and 4.30 - 6.30 p.m. Monday to Friday except as agreed in writing by the Director

11 SAFETY

11.1 During the periods when the Highway Works are being carried out the Developer shall provide all watching and lighting as required and shall maintain all lights, guards, fencing, warning signs when and, where necessary, undertake such further measures as may be reasonably required by the Director

12 ACCOMMODATION WORKS

12.1 The Developer shall carry out or ensure that there shall be carried out all related accommodation works associated with the Highway Works

13 CONSTRUCTION (DESIGN AND MANAGEMENT) REGULATIONS 2015

13.1 The Developer shall be the only client for the purpose of the CDM Regulations and the Developer agrees to undertake the obligations of a client under the CDM Regulations and to use all reasonable endeavours to ensure that the Highway Works are carried out in accordance with the CDM Regulations

13.2 The Highway Works shall not commence until the Developer as the only client has provided to the Director:

13.2.1 an estimate of the number of working days and/or person days of construction work and the number of workers working on site simultaneously at any one point in the project which the Contract will entail

13.2.2 written details of the principal designer and the principal contractor appointed for the project and also provide copies of the Construction Phase Plan and Health & Safety File

13.2.3 a copy of the Notification of Project (form HSE F10) to the HSE pursuant to Regulation 6 of the CDM Regulations

13.3 Throughout the Highway Works the Developer shall provide to the Director copies of the updates and revisions to the construction phase plan and Health and Safety File pursuant to Regulation 12

13.4 Within twenty-eight (28) days of issue of the Certificate of Substantial Completion for any or all of the Highway Works the Developer shall provide to the Director

- 13.4.1 a plan showing the land over which those Highways Works have been constructed and
 - 13.4.2 a Health and Safety file conforming in all respects with the CDM Regulations and which shall accord with the current format used by the County Council to include a separate Health and Safety File for each Highway Structure
- 13.5 The Director shall be at liberty to delay issue of the Certificate of Final Completion in respect of any of the Highway Works if the Developer fails to provide the Director with the documents referred to in 13.4.1 and 13.4.2 above within twenty-eight (28) days of issue of any Certificate of Substantial Completion for any of the Highway Works equivalent to the number of days after the twenty-eight (28) day period that the documents were submitted
- 13.6 In respect of the Highway Works generally the Developer shall provide to the Director the final information in both paper and electronic format and shall at least comprise:
- 13.6.1 1:500 scale (or alternative scale as may be specified by the Director) "as built" drawings
 - 13.6.2 records of the earthworks showing sources of material used in areas of fill description of fill materials descriptions of sub-grades in cut areas copies of results of tests of material carried out as part of the supervision of the construction of the earthworks
 - 13.6.3 records of the sources of supply of all deliveries of road construction materials with details of the location of the Highway Works at which each load is placed
 - 13.6.4 records of the sources of supply of all other manufactured materials (e.g. drainage goods, fencing materials, traffic signs, electrical components and cables etc).
- 13.7 No work on Highway Structures shall commence until the general Health and Safety file information including format to be supplied in respect of Highway Structures has been agreed with the County Council's Bridge Engineer and shall accord with the County Council's current Technical

Approval Procedure for Highway Structures

13.8 The Developer shall indemnify and keep the County Council indemnified against any breach of the Developer's obligations under this paragraph
13

14 SITE CLEARANCE AND CERTIFICATE(S) OF SUBSTANTIAL COMPLETION

14.1 On Substantial Completion of the Highway Works the Developer shall:-

14.1.1 clear away and remove from the site of the Highway Works all constructional plant and temporary works of every kind and leave the site of the Highway Works in a neat and tidy condition to the satisfaction of the Director and

14.1.2 carry out stage 3 of the Road Safety Audit process and comply to the satisfaction of the Director with recommendations arising thereunder prior to the opening of the Highway Works to the public

14.2. Upon Substantial Completion of the Highway Works including any additional work resulting from stage 3 of the Road Safety Audit process to the satisfaction in all respects of the Director he shall issue a Certificate of Substantial Completion in respect of those Highway Works to the Developer provided that all costs and expenses owing to the County Council have been paid in respect of those Highway Works

14.3. The Developer hereby agrees that on the date of Substantial Completion that part of the Site upon which the Highways Works are constructed which does not currently form part of the public highway shall be dedicated as highway under section 38 of the 1980 Act

14.4. After the issue of the Certificate of Substantial Completion the County Council may approve a reduction of up to 90% of the Performance Figure in respect of the relevant Highway Works and the County Council may release the Developer and the Performance Bond Surety and each of them from their obligations under the Performance Bond in respect of the relevant Highway Works to such extent

15 DEFECTS CORRECTION PERIOD AND CERTIFICATE OF FINAL COMPLETION

- 15.1 The Developer shall maintain each and all of the Highway Works for a period of eighteen (18) months (unless the Director agrees in writing a lesser period having considered paragraph 15.2) from the issue of the related Certificate of Substantial Completion and prior to the expiration of this period the Developer shall reinstate and make good any damage or defect which may have arisen from any cause whatsoever or be discovered during the said period of eighteen months (including any defect in or damage to the surface water drainage system) so as to place the highway and the Highway Works in a condition satisfactory to the Director
- 15.2 After the expiration of the period of twelve (12) months from Substantial Completion or the date the Development becomes operational (whichever is the latter) the Developer shall (unless the Director writes to the Developer informing him that it is to be carried out sooner or that he does not need to do so) carry out stage 4 of the Safety Audit and comply to the satisfaction of the Director with any recommendations arising thereunder
- 15.3 After the expiration of the period of eighteen (18) months referred to in paragraph 15.1 (or such lesser period as agreed in writing by the Director under paragraph 15.1) and after any defects have been made good as therein provided including any improvements arising under stage 4 of the Road Safety Audit to the satisfaction of the Director and after the provisions of paragraph 13.4 and paragraph 20.2 of this Schedule have been fulfilled the Director shall issue forthwith to the Developer the Certificate of Final Completion in respect of the Highway Works provided that the Certificate of Final Completion shall in the case of road gullies extend only as far as their points of entry to the surface water sewers where those are not being adopted by the County Council as highway drains and upon the issue of the Certificate of Final Completion the County Council shall release the Developer and the Performance Bond Surety and each of them from all subsisting obligations under the Performance Bond in respect of those Highway Works
- 15.4 If called upon to do so by notice in writing served within twenty-one years of the date hereof by the County Council the Developer agrees to transfer to the County Council in consideration of one pound any land

over which any part of the Highway Works have been constructed which does not at the date of this Agreement already form part of the highway together with any other land dedicated as public highway by the Developer hereunder free from encumbrances and together with all rights necessary to permit the use inspection maintenance repair and replacement of all utility systems servicing the Highway Works and not vested in the relevant undertaker as are situated outside the limits of the Highway Works and the said other land

16 INDEMNITY

16.1 The Developer shall from the date of this Agreement indemnify the County Council against all claims charges costs expenses liability or loss whatsoever arising out of and incidental to any or all of the Highway Works including but not limited to those arising out of any legally sustainable claims for payments under Section 10 of the Compulsory Purchase Act 1965 and Part I of the Land Compensation Act 1973 (as amended) in connection with those Highway Works provided that the Developer's indemnity will not extend to any claims submitted to the County Council arising out of the negligence of the County Council's employees or arising out of any works of alteration carried out to any of the Highway Works by the County Council after the issue of the related Certificate of Final Completion

16.2 The County Council shall notify the Developer forthwith upon receipt of any such claim or liability

16.3 The County Council shall not accept or settle any claim without first having given the Developer the opportunity to provide the County Council with representations as to the validity of such claim

16.4 The indemnification referred to in paragraph 16.1 includes:

16.4.1 all fees incurred by claimants which the County Council is obliged to pay, and those of the County Council or its agent or contractor, in negotiating any claims (together with VAT payable on the claimants' professional advisors' fees);

16.4.2 statutory interest payments to claimants and their professional advisors; and

16.4.3 the County Council's reasonable and proper legal costs in making the compensation, fees and interest payments

17 PERFORMANCE BOND

17.1 Without expense to the County Council the Developer and the Performance Bond Surety shall on the date of this Agreement enter into the Performance Bond for each and all of the Highway Works and the Developer and Performance Bond Surety shall be bound to the County Council in the amount of the Performance Figure for the Highway Works

17.2 Should the Developer default in the execution of its obligations to carry out any or all of the Highway Works and to maintain the same in accordance with the provisions of this Agreement then the County Council may (subject to the provisions hereinafter contained) itself carry out the Highway Works and maintain the same as aforesaid having first called upon the Performance Bond Surety for the cost to be expended in so doing

17.2.1 Unless there is a danger to users of the highway the County Council shall give twenty (20) working days prior written notice (or lesser period as may in the circumstances be reasonable) of its intention to commence work under Paragraph 17.2

17.2.2 any notice served under this paragraph shall specify the period of the notice ("the Notice Period") the extent of the work which the County Council proposes to carry out and full details of all matters in respect of which the Director considers that the Highway Works have not been carried out in accordance with the terms of this Agreement

17.2.3 if before the expiry of the Notice Period the Developer serves written notice upon the County Council that the Developer intends diligently to execute the works specified in the notice in accordance with the terms of this Agreement and specifies a time to complete that the County Council considers reasonable in the circumstances the County Council shall not be entitled to execute the relevant part or parts of the Highway Works specified in the notice served under this paragraph unless the

Developer then fails to execute those works within the agreed time scale

17.3 If the Developer should default in the execution of its obligations to carry out any or all of the Highway Works and to maintain the same in accordance with the provisions of this Agreement then the County Council will call upon the Performance Bond Surety to provide the full Performance Figure (or such sum that remains following reduction of the Performance Bond in accordance with Paragraph 14.4 of this Schedule) in accordance with this Agreement. Save that the County Council after all works are completed and all contracts and any contract claims settled will return any Performance Bond sum unused with interest at the Bank of England Base Rate minus 2 basis points, compounding annually at financial year end on receipt of a written request to the Performance Bond Surety within one month of all the aforementioned completing and settling. If for any period the Bank of England Base Rate is at or below 0.02% then no interest shall be payable for that period by any party to this Agreement

18 COMMUTED SUMS FOR MAINTENANCE

18.1 Prior to the date of this Agreement the Developer shall pay to the County Council the Commuted Sums calculated as follows:

	£
Roads	5,333.88
Street Lighting	13,997.00
Drainage	5,979.37
Verges, Trees and Street Furniture	920.59

19 LEGAL AND ADMINISTRATIVE COSTS

19.1 The Developer shall pay to the County Council:-

19.1.1 the whole of the costs of the County Council's Legal Services Department in connection with the preparation and completion of

this Agreement and these costs shall be payable prior to sealing of this Agreement;

- 19.1.2 interest at four per cent above the Bank of England Base Rate from time to time on any sum due to the County Council under this Agreement which is outstanding for more than twenty-eight (28) days from the date on which it was demanded or in the event that a dispute or difference regarding such payment is referred to arbitration pursuant to clause 4.1 of this Agreement the said twenty-eight (28) day period shall run from the date of the decision of the arbitrator (such interest to be charged on the amount outstanding each day from the date of issue of a written demand for any sum due or in the event that a dispute or difference regarding such payment is referred to arbitration pursuant to clause 4.1 of this Agreement such interest to be charged on the amount outstanding each day from the date of issue of the decision of the arbitrator)
- 19.1.3 The greater of £5000 (Five thousand pounds) or 7½% of the Performance Figure (excluding the costs associated with statutory undertakers work and traffic management) for the Highway Works towards the costs and expenses of the County Council of checking the design of each and all of the Highway Works and inspecting each and all of the Highway Works such sum shall be payable prior to sealing of this Agreement
- 19.1.4 the reasonable cost to the County Council of undertaking Road Safety Audits and also the cost of the safety checks of details submitted which sum shall be payable prior to the safety audit commencing
- 19.1.5 the cost of any temporary and permanent traffic regulation orders which sum shall be payable prior to any work on the making of such order being commenced
- 19.1.6 the full cost of any other road traffic orders required to facilitate the Highway Works which sum shall be payable prior to any work on the making of such order being commenced

Part I and II Claims

[Part I Claims - Depreciation Caused By Public Works

20.1 The Developer hereby undertakes and agrees with the County Council that in the event of any claim for compensation or otherwise or costs or charges arising in connection with or incidental to or in consequence of the carrying out of the Highway Works whether mandatory or discretionary which may be incurred by virtue of any enactment or statutory instrument and otherwise hereby provided for he will hold the County Council fully indemnified from and against all claims charges costs and expenses in connection therewith or arising therefrom

Part II Claims

20.2 The Developer covenants with the County Council to comply with the requirements of the Noise Insulation Regulations 1975 (SI 1975/1763) as amended and to provide to the County Council such evidence as is required by the Director to demonstrate compliance with the Noise Insulation Regulations 1975 prior to the issuing by the County Council of the Certificate of Final Completion in accordance with paragraph 15.3 of this Schedule

00045/24

SCHEDULE II.A

Performance Bond Agreement

DATED 6th February 2024

BENNETT PLC (1)

- and -

NATIONAL HOUSE-BUILDING COUNCIL (2)

PERFORMANCE BOND

relating to the development of land on the west side of Station Terrace, Framlingham,
Suffolk

BY THIS BOND BENNETT PLC of Low Green Barn, Nowton, Bury St Edmunds, Suffolk, IP29 5ND ("the Developer") and

NATIONAL HOUSE-BUILDING COUNCIL ("the Surety") are held and firmly bound to **SUFFOLK COUNTY COUNCIL** of Endeavour House 8 Russell Road Ipswich Suffolk IP1 2DH ("the County Council") in the sum of £117,649.69 (One Hundred and Seventeen Thousand, Six Hundred and Forty-Nine Pounds and Sixty-Nine Pence) to be paid to the County Council for the payment of which sum the Developer and the Surety bind themselves their successors and assigns jointly and severally

IN WITNESS whereof the Developer and the Surety have hereunto executed and delivered

the same on but not before this *6th* day of *February* Two thousand and *Twenty*
four

1. The Developer has entered into an Agreement under seal with the County Council of even date made under Section 278 of the 1980 Act whereby the Developer undertook at its own expense to carry out works as set out in Schedule III of the said Agreement and shown in the Works Drawings annexed to the said Agreement ("the Highway Works")
2. It is intended that this Bond shall be construed as one with the said Agreement

NOW THE CONDITION of the above-written Bond is such that if the Developer shall duly perform and observe all the terms provisions conditions and stipulations of the said Agreement (in so far as they relate to the Highway Works) on the Developer's part to be performed and observed according to the true intent and meaning thereof or if on default by the Developer the Surety shall duly satisfy and discharge the damages sustained by the County Council up to the amount of the above-written Bond then the above-written Bond shall be null and void but otherwise shall remain in full force and effect **PROVIDED ALWAYS** that the giving by the County Council of any extension of time for performing the said Agreement or any stipulations

SCHEDULE II.B *Not Used*

SCHEDULE III

The Highways Works comprising the following works:

<u>Location</u>	<u>Works</u>	<u>Delivery Programme</u>
<u>Clarke Drive</u>	<u>Extension of shared surface over cycleway</u>	

Timescales: The Highways Works are to be commenced within 12 (twelve) months of the date of this Agreement and completed within 6 (six) months of commencement of the Highway Works

SCHEDULE IV

Approved List of drawings

	Title	Drawing number
1.	ROAD SETTING OUT	2210-754 001
2.	ROAD LONGSECTIONS	2210-754-002
3.	ADOPTABLE ROAD CONSTRUCTION DETAILS SHEET 1	2210-754 003A
4.	ADOPTABLE ROAD CONSTRUCTION DETAILS SHEET 2	2210-754 004C
5.	SITE CLEARANCE PLAN	2210-754 005
6.	ENGINEERING LAYOUT	2210-754 006A
7.	S278 FLOW CONTROL CONSTRUCTION DETAIL	2210-754 007A
8.	S278 LONGSECTION & SCHEDULE	2210-754 008A
9.	LAND DEDICATION PLAN	2210-754 277A
10.	SECTION 278	2210-754-278 D



EXISTING KERB TO BE REMOVED TO ALLOW FOR EXTENSION OF ROAD

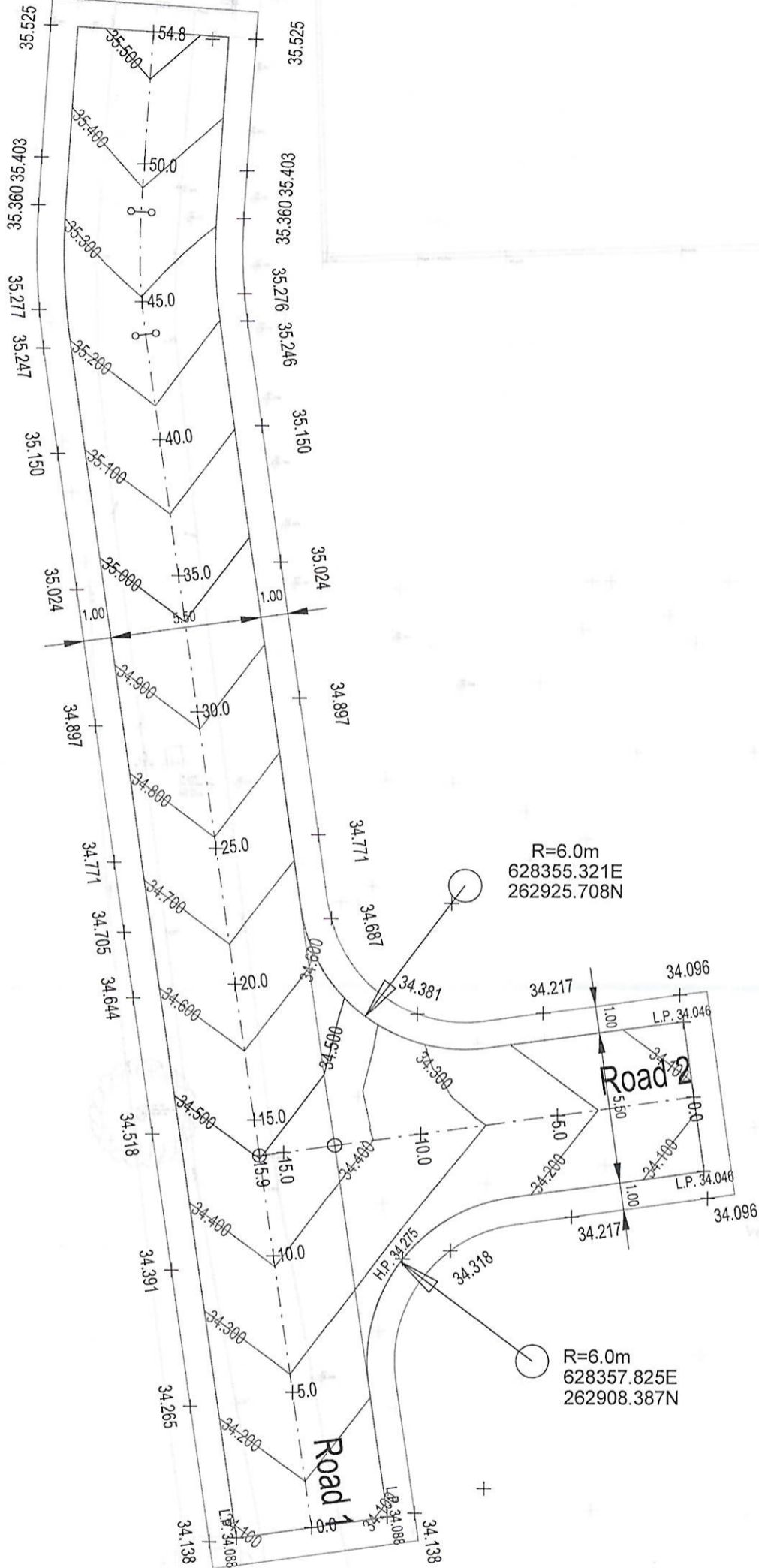

- GENERAL**
1. THIS DRAWING IS TO BE READ IN CONJUNCTION WITH ALL OTHERS.
 2. THIS DRAWING IS TO BE READ IN CONJUNCTION WITH ALL OTHERS.
 3. ANY EXISTING DETAILS WHICH ARE SHOWN ON THIS DRAWING ARE FOR GUIDANCE ONLY AND ARE TO BE CHECKED ON SITE BY THE CONTRACTOR. ANY VARIATIONS ARE TO BE RECORDED AND REPORTED TO THE ENGINEER IMMEDIATELY FOR AND MUST TAKE ALL NECESSARY PRECAUTIONS TO ENSURE THE STABILITY OF THE WORKS AT ALL TIMES DURING CONSTRUCTION.
 4. ALL WORKMANSHIP AND MATERIALS ARE TO BE TO CURRENT BRITISH STANDARDS.
 5. ALL SERVICES ARE TO BE LOCATED AND PROTECTED AS NECESSARY BY THE CONTRACTOR PRIOR TO THE COMMENCEMENT OF THE WORKS.
 6. ANY EXISTING DETAILS WHICH ARE SHOWN ON THIS DRAWING ARE FOR GUIDANCE ONLY AND ARE TO BE CHECKED ON SITE BY THE CONTRACTOR. ANY VARIATIONS ARE TO BE RECORDED AND REPORTED TO THE ENGINEER IMMEDIATELY.
 7. ALL HIGHWAY WORKS ARE TO BE IN ACCORDANCE WITH THE LOCAL AUTHORITIES DESIGN GUIDE AND SPECIFICATION.
 8. PRIOR TO THE OCCUPATION OF THE FIRST DWELLING STREET NAMEPLATES SHALL BE ERRECTED IN ACCORDANCE WITH THE HIGHWAY AUTHORITY AND TO THE WORDING AGREED WITH THE PLANNING AUTHORITY.
 9. DURING CONSTRUCTION WORKS ON SITE, ALL ROADS AND FOOTPATHS ARE TO BE SWEEPED AND KEPT CLEAR OF OBSTRUCTIONS. THIS IS TO INCLUDE EXISTING HIGHWAYS AS APPROPRIATE TO ENSURE SAFE PASSAGE OF ALL ROAD USERS.
 10. PROVISION SHALL BE MADE FOR THE INSTALLATION OF ALL MAINS SERVICES INCLUDING DUCTING PRIOR TO THE LAYING OF THE ROAD BASE-COURSE.
 11. ALL ROAD MARKINGS AND SIGNS ARE TO BE IN ACCORDANCE WITH THE TRAFFIC SIGNS REGULATIONS AND DIRECTIONS 2015.

Road 1				
Chainage (m)	Easting (m)	Northing (m)	Level (m)	Curve/Straight
0.000	628349.866	262902.285	34.157	Start
5.000	628349.151	262907.234	34.283	Straight
10.000	628348.435	262912.182	34.410	Straight
15.000	628347.720	262917.131	34.536	Straight
20.000	628347.005	262922.079	34.663	Straight
22.399	628346.662	262924.454	34.724	IP
25.000	628346.295	262927.029	34.789	Straight
30.000	628345.591	262931.979	34.916	Straight
35.000	628344.887	262936.929	35.043	Straight
40.000	628344.183	262941.879	35.169	Straight
43.801	628343.648	262945.642	35.265	Tangent Point
45.000	628343.511	262946.833	35.296	Curve Radius 22.0
48.275	628343.471	262950.105	35.378	Tangent Point
50.000	628343.578	262951.827	35.422	Straight
54.793	628343.875	262956.611	35.543	End

Road 2				
Chainage (m)	Easting (m)	Northing (m)	Level (m)	Curve/Straight
0.000	628363.654	262918.042	34.115	Start
5.000	628358.703	262917.347	34.236	Straight
10.000	628353.752	262916.651	34.358	Straight
13.151	628350.631	262916.213	34.434	IP at Channel
15.000	628348.801	262915.948	34.480	Straight
15.901	628347.910	262915.820	34.503	End

[Handwritten signatures and initials]

Revision Notes		Drawn	Appr	Date
INGENT				
CONSULTING ENGINEERS				
Unit 10 Brightwell Barns, Waldringfield Road, Brightwell, Suffolk, IP10 0BJ Tel: 01473 598038 --- www.ingent.co.uk --- email: info@ingent.co.uk				
worksafe consultant		SSIP		COMS
PRELIMINARY				
Project: STATION TERRACE, FRAMLINGHAM				
Drawing Title: ROAD SETTING OUT				
Client: BENNETT HOMES		Date: DEC 22		
Drawn: JS	Designed: JS	Checked: RGW	Approved: RGW	
Scale: 1:100				
Project No: 2210-754		Drawing No & Revision: 001		Size: A1

GENERAL
 1. DO NOT SCALE THIS DRAWING. ALL DIMENSIONS ARE IN METRES UNLESS OTHERWISE NOTED. ANY DISCREPANCIES ARE TO BE RECORDED AND REPORTED TO THE ENGINEERS IMMEDIATELY.
 2. THIS DRAWING IS TO BE READ IN CONJUNCTION WITH ALL OTHER ENGINEERS AND ARCHITECTS DRAWINGS AND THE SPECIFICATION.
 3. ANY EXISTING DETAILS WHICH ARE SHOWN ON THIS DRAWING ARE FOR GUIDANCE ONLY AND ARE TO BE CHECKED ON SITE BY THE CONTRACTOR. ANY VARIATIONS ARE TO BE RECORDED AND REPORTED TO THE ENGINEER IMMEDIATELY.

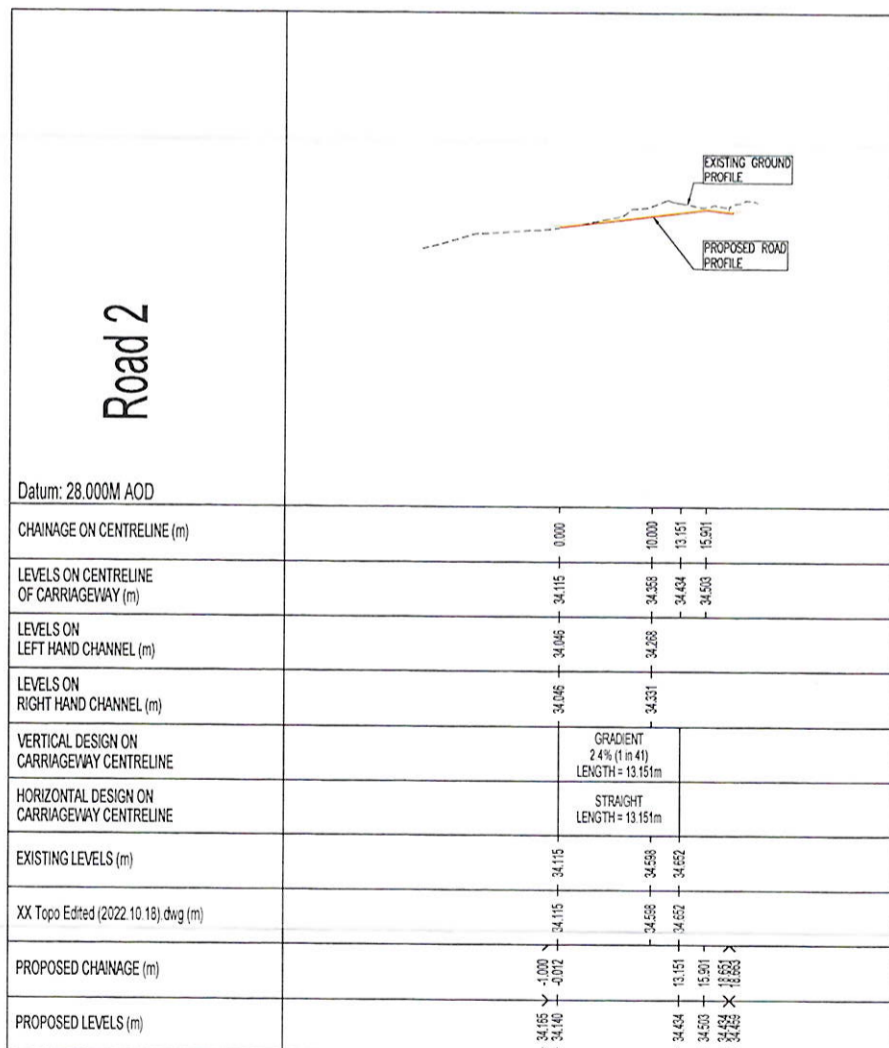
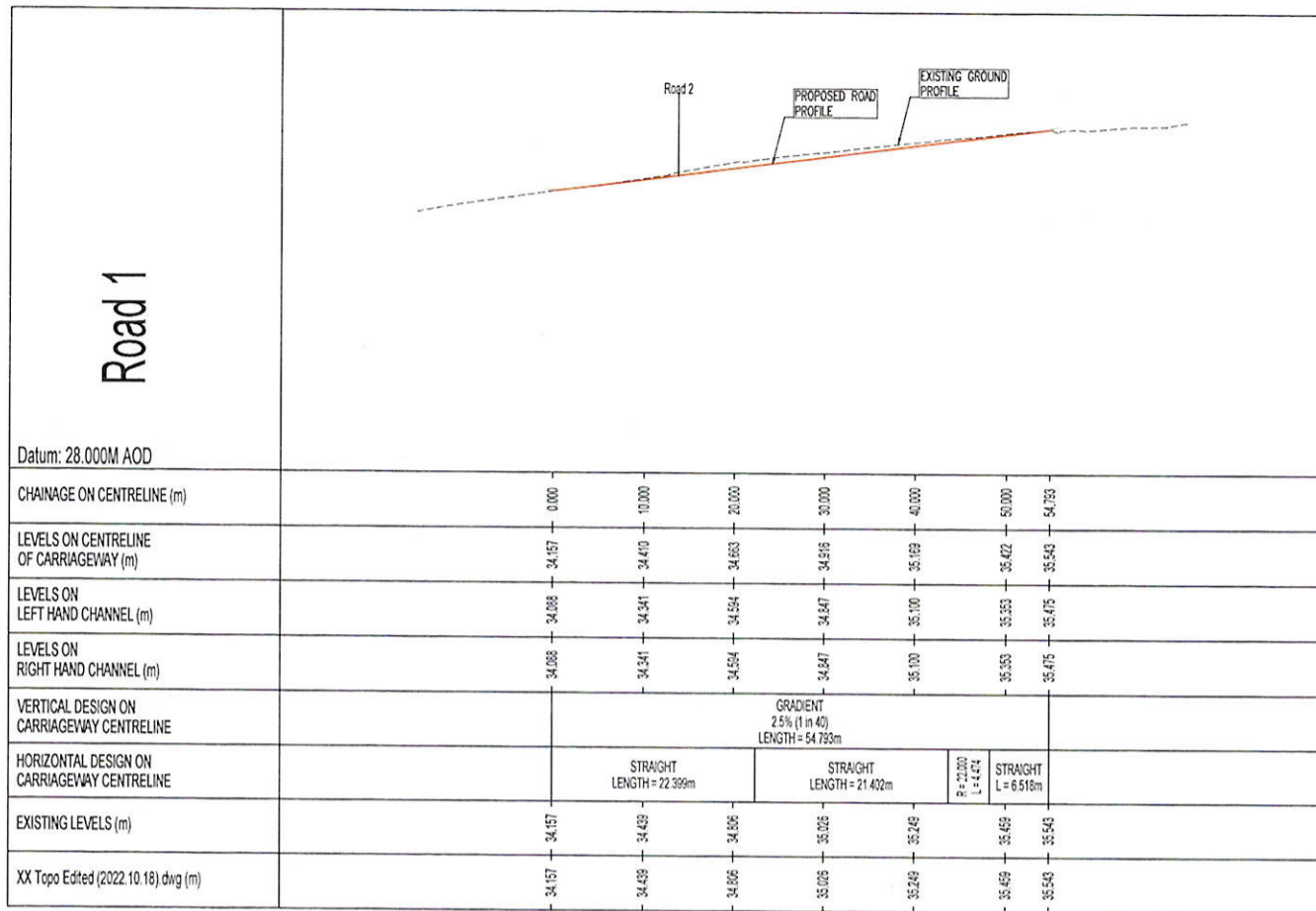

[Handwritten signatures]

INGENT CONSULTING ENGINEERS	
Unit 10 Brightwell Barrs, Waldringfield Road, Brightwell, Suffolk, IP10 0BJ Tel: 01473 598038 --- www.ingent.co.uk --- email: info@ingent.co.uk	
worksafe consultant	SSIP
PRELIMINARY	
Project: STATION TERRACE, FRAMLINGHAM	
Drawing Title: ROAD LONGSECTION	
Client: BENNETT HOMES	Date: DEC 22
Drawn: JS	Designed: JS
Checked: RGW	Approved: RGW
Scale: Horizontal 1:500, Vertical 1:100	
Project No: 2210-754	Drawing No & Revision: 002
Size: A1	

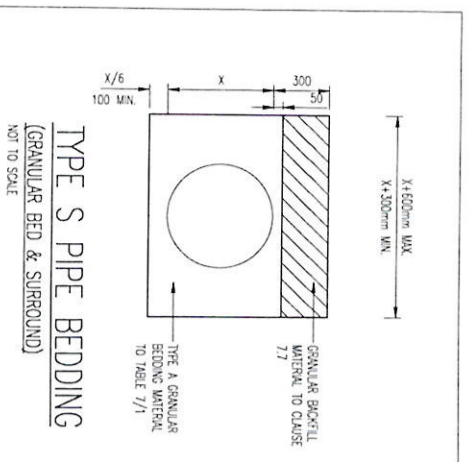

- TYPE S NOTES**
1. ALL DIMENSIONS ARE IN MILLIMETRES
 2. DIMENSION X IS THE EXTERNAL DIAMETER OF THE PIPE
 3. THE MINIMUM OR MAXIMUM WIDTH OF THE TRENCH APPLIES ON AND BELOW A LINE 300mm ABOVE THE OUTSIDE TOP OF THE PIPE ABOVE THE 300mm LINE THE TRENCH BACKFILL MATERIAL SHALL BE AS DESCRIBED IN CLAUSE 7.7

TABLE 7/1

PIPE DIAMETER (mm)	SINGLE SIZE AGGREGATE (mm) TO BS 882
LESS THAN 150mm	10
INCLUDING 150mm UP TO 300mm	10 OR 14
INCLUDING 300mm UP TO 525mm	14 OR 20
INCLUDING 525mm AND ABOVE	14, 20 OR 40

TABLE A

PIPE N MANHOLE (mm) DIAMETER (mm)	CHAMFER SECTION DIAMETER (mm)
LESS THAN 375mm	1200, REDUCING TO 1050 WHERE DEPTH OF SPRTT IS BETWEEN 1.2m AND 1.5m
375-450	1350
450-700	1500
750-900	1800

NOTES

1. DIMENSIONS ARE IN MILLIMETRES UNLESS OTHERWISE STATED.
2. THE SPECIFICATION FOR ALL HIGHWAY WORKS IS THE 'MANUAL OF CONTRACT DOCUMENTS FOR HIGHWAY WORKS, VOLUME 1, SPECIFICATION FOR HIGHWAY WORKS - HIGHWAYS AGENCY, MARCH 1987'. ALL EXHIBITS ARE TO BE IN ACCORDANCE WITH APPENDIX D OF THE NORFOLK COUNTY COUNCIL RESIDENTIAL ESTATE ROAD CONSTRUCTION SPECIFICATION, WHERE THERE ARE ANY DISCREPANCIES BETWEEN THE ABOVE DOCUMENTS THE NORFOLK COUNTY COUNCIL DESIGN GUIDES SHOULD BE FOLLOWED.
3. ALL PRECAST CONCRETE KERBS AND EDGINGS TO BE LAD AND BEDDED IN ACCORDANCE WITH BS 7533, PART 4 ON A MAX SIZE CONCRETE FOUNDATION WHILE IT IS STILL PLASTIC OR AFTER IT HAS SET.
4. ALL PRECAST UNITS TO BE HAUNCHED WITH MAX SIZE CONCRETE.
5. ALL PRECAST KERBS LAD TO SMOOTH HORIZONTAL AND VERTICAL ALIGNMENTS - ALIGNMENT SHALL NOT DEVIATE BY MORE THAN 3mm IN 2m FROM LINE AND LEVEL.
6. FOR CURVES OF RADIUS 12m OR LESS PRECAST KERBS OF APPROPRIATE RADIUS SHALL BE USED.
7. MANUFACTURE OF KERBS, EDGINGS AND PAVING TO BE IN ACCORDANCE WITH BS EN 1239: 2003.
8. BLOCK PAVING TO BE LAD IN A 45 DEGREE HERRINGBONE PATTERN WITH 2 STRETCHER COURSES ADJACENT TO KERBS.
9. WHEN A SHRED SURFACE ROAD IS TAKEN FROM A ROAD WITH FOOTWAYS, THE FOOTWAY SHALL BE EXTENDED PAST THE TOP OF THE ROAD 1.8 METRES.
10. THE BACK OF ADAPTABLE LANDSCAPING AREAS ADJACENT TO A SHRED SURFACE HIGHWAY ARE TO BE DELINEATED BY A 0.9m PRECAST CONCRETE EDGING KERB LAD WITH SPACING GAPS OF 1.5m EDGE TO EDGE.
11. COMPACTNESS OF BITUMINOUS MATERIALS IS TO BE IN ACCORDANCE WITH CLAUSE 901.
12. THICKNESSES OF SUB-BASE AND THE REQUIREMENT FOR A CAPPING LAYER SHALL BE DETERMINED BY ON SITE CBR TESTING.

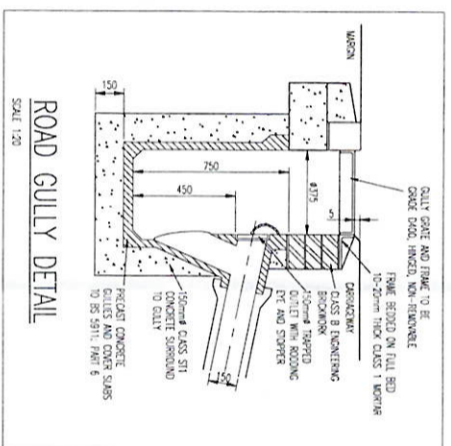

- GULLY NOTES:**
1. GULLY FRAME TO BE SET ON 10-20mm THICK CLASS 1 CEMENT MORTAR BED, TO CLAUSE 2404.
 2. BRICKWORK - MIN. ONE AND NOT MORE THAN THREE COURSES OF CLASS B ENGINEERING BRICKWORK. LAND SQUARE CHANGE IN PROFILE FROM SQUARE TO CIRCULAR TO BE SHIPPED IN CLASS 1 MORTAR.
 3. WHERE THE GULLY CONNECTION PIPE PASSES UNDER THE CARRIAGEWAY THE INVERT OF THE PIPE AT THE OUTLET SHALL BE SET AT LEAST 175mm BELOW FORMATION LEVEL. THE INVERT SHALL BE AT LEAST 315mm BELOW THE TOP OF THE SUB-BASE.
 4. THE GRATING AND FRAME SHALL BE SET 5mm BELOW THE CARRIAGEWAY SURFACE AND FLUSH WITH THE KERB FACE; ANY GAP TO BE FILLED WITH CLASS 1 MORTAR.

- GENERAL**
1. DRAWING SCALE THIS DRAWING - ALL DIMENSIONS ARE IN METRES UNLESS OTHERWISE NOTED. ANY DISCREPANCIES ARE TO BE RECORDED AND REPORTED TO THE ENGINEERS IMMEDIATELY.
 2. THIS DRAWING IS TO BE READ IN CONJUNCTION WITH ALL OTHER ENGINEERS AND ARCHITECTS DRAWINGS AND THE SPECIFICATION.
 3. ANY EXISTING DETAILS WHICH ARE SHOWN ON THIS DRAWING ARE FOR GUIDANCE ONLY AND ARE TO BE CHECKED ON SITE BY THE CONTRACTOR. ANY VARIATIONS ARE TO BE RECORDED AND REPORTED TO THE ENGINEER IMMEDIATELY.

NOTES

1. AGGREGATE SIZES IN REGULATING MATERIAL SHALL BE APPROPRIATE TO THE THICKNESS LAD SEE THE TABLE OF MOUND AND MANHOLE THICKNESS IN BS 5949/87
2. REFER TO APPENDIX 7/1 TO PERMITTED MATERIAL AND THICKNESSES
3. EXISTING CARRIAGEWAY WITH UNBOUND LAYERS OF NEW CONSTRUCTION SHALL BE REMOVED OR REPERFORATED TO ALLOW DRAINAGE
4. JOINTS TO BE SEALED IN ACCORDANCE WITH BS 5949/87

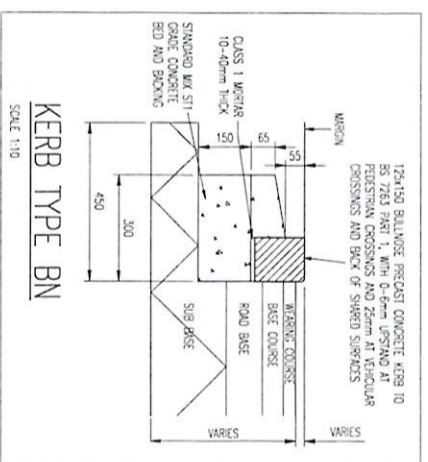
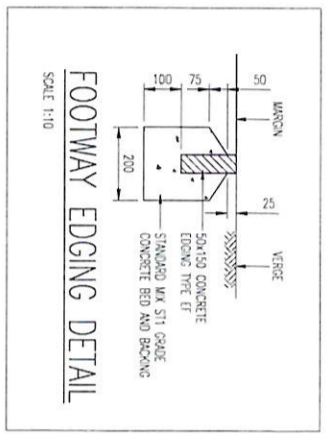
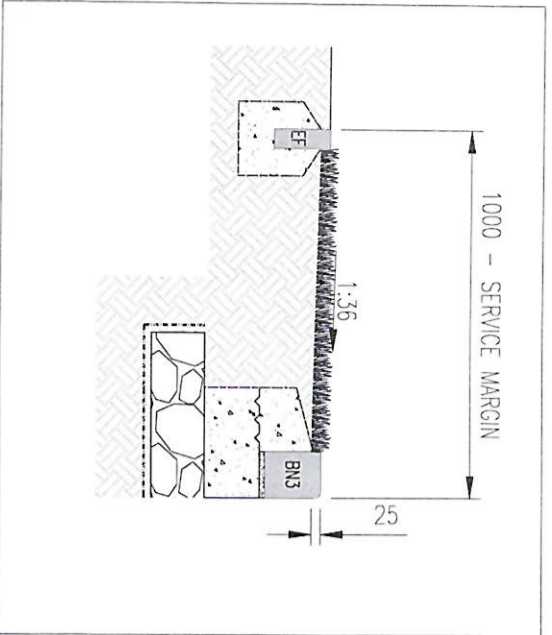
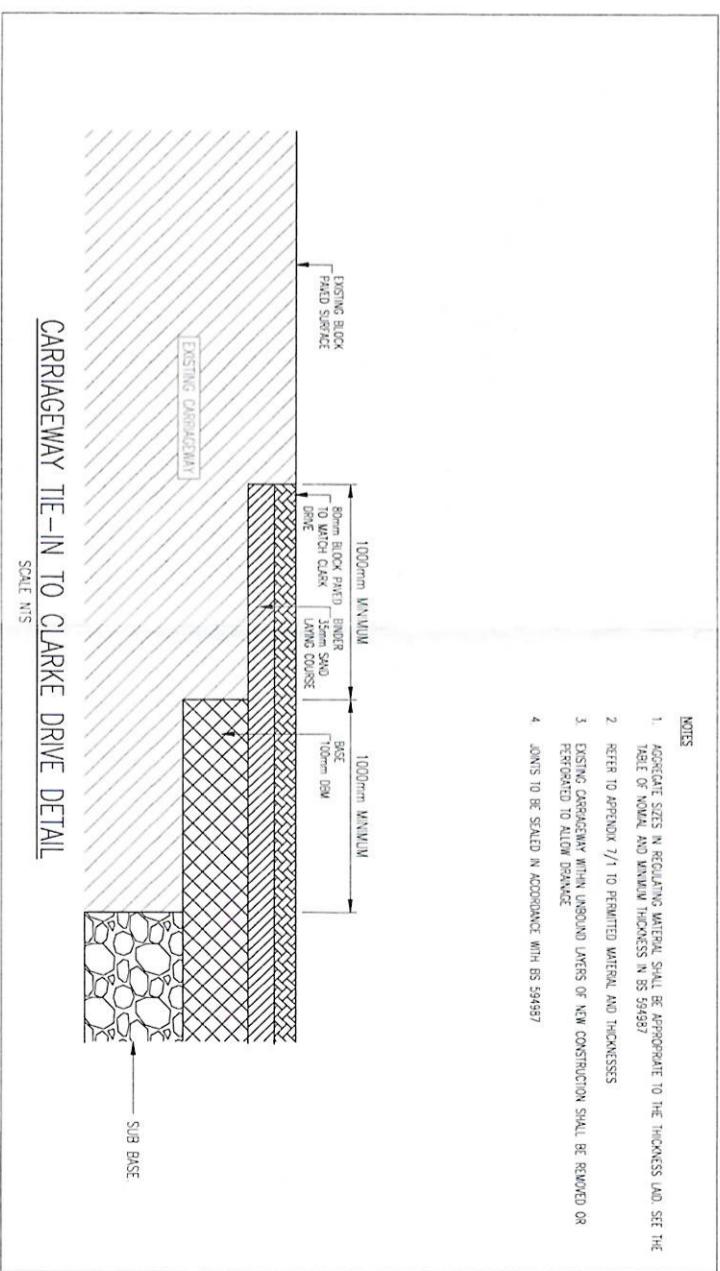

Handwritten signatures and initials.

INGENIT CONSULTING ENGINEERS
 Unit 10 Blythwell Barns, Walsingham Road, Blyth, North East, Norfolk, UK
 Tel: 01493 555558 www.ingenit.co.uk email: info@ingenit.co.uk

worksafe SSIP
 www.worksafe.co.uk

COMS
 www.coms.co.uk

PRELIMINARY

Project: STATION TERRACE
 Framlingham

Drawing Title: ADAPTABLE ROAD CONSTRUCTION DETAILS

Client	BENNETT HOMES	Date	DEC 2022
Drawn	JS	Checked	RGW
Designed	JS	Approved	RGW
Scale	As Shown		
Project No	2210-154	Drawing No & Revision	003A
		Size	A1

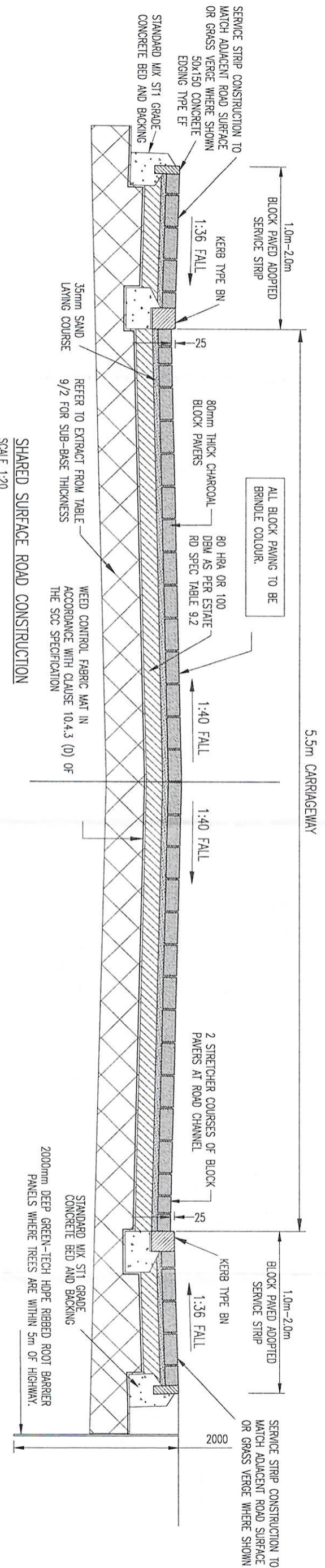

EXTRACT FROM TABLE 9/2 OF SUFFOLK COUNTY COUNCIL SPECIFICATION FOR ESTATE ROADS

TYPE OF ROAD	DEPTH OF SUB-BASE FOR CUR VALUES (mm)	ROAD BASE DEPTH (mm)	SUBGRADING DEPTH (mm)	SURFACE COURSE					
SHARED SURFACE ROAD	<2%	2%	3%	4%	5%	80 HBA / 100 DBM	LEAN CONC.	BINDER COURSE	SURFACE COURSE
	SEE NOTE 1	370	280	225	225	80 HBA / 100 DBM	---	80mm THICK CONCRETE BLOCKS ON 35mm SAND	---

- NOTES:
1. REFER TO DRAWINGS 1906-366, 632 & 633 FOR GUIDANCE ON MEASURED CURVE AND REQUIRED THICKNESS OF SUBBASE.
 2. WHERE THE SUB-GRADE IS FOUND UNSUITABLE, THE SUB-BASE DEPTH SHALL BE INCREASED TO PROVIDE A MINIMUM CONSTRUCTION DEPTH OF 450mm.
 3. IF ANY AREAS OF CUR LESS THAN 2% ARE FOUND, THE ENGINEER SHOULD BE CONSULTED.
 4. ALL WORKS ARE TO BE TO THE SPECIFICATION FOR ESTATE ROADS MAY 2007, BY SUFFOLK COUNTY COUNCIL.
 5. ROAD STRIP WIDTH IS REQUIRED TO BE INCREASED BY 25mm IN DESIGN THICKNESS TO ALLOW FOR ON-SITE CONSTRUCTION TOLERANCE.

NOTE:
THE ROAD FORMATION IS TO BE APPROVED BY SUFFOLK COUNTY COUNCIL PRIOR TO THE PLACING OF ANY SUB-BASE MATERIAL.

- GENERAL
1. DO NOT SCALE THIS DRAWING. ALL DIMENSIONS ARE IN METERS UNLESS OTHERWISE NOTED. ANY DISCREPANCIES ARE TO BE RECORDED AND REPORTED TO THE ENGINEERS IMMEDIATELY.
 2. THIS DRAWING IS TO BE READ IN CONJUNCTION WITH ALL OTHER ENGINEERS AND ARCHITECTS DRAWINGS AND THE SPECIFICATION.
 3. ANY EXISTING DETAILS WHICH ARE SHOWN ON THIS DRAWING ARE FOR GUIDANCE ONLY AND ARE TO BE CHECKED ON SITE BY THE CONTRACTOR. ANY VARIATIONS ARE TO BE RECORDED AND REPORTED TO THE ENGINEERS IMMEDIATELY.

[Handwritten signatures and initials]

<p>INGENT CONSULTING ENGINEERS Unit 10, Bosphorus Farm, Walsingham Road, Bosphorus, Suffolk, IP11 0BA Tel: 01473 558133 www.ingent.co.uk email: info@ingent.co.uk</p>		<p>worsdale SSIP www.worsdale.co.uk</p>		<p>COMS www.coms.co.uk</p>	
<p>Project: STATION TERRACE FRAMLINGHAM</p>			<p>Client: BENNETT HOMES</p>		
<p>Drawing Title: ADAPTABLE ROAD CONSTRUCTION DETAILS</p>			<p>Date: DEC 2022</p>		
<p>Scale: As Shown</p>			<p>Drawn: JS</p>		
<p>Project No: 2210754</p>			<p>Checked: RGW</p>		
<p>Drawing No. & Revision: 004C</p>			<p>Approved: RGW</p>		
<p>Size: A1</p>			<p>Scale: As Shown</p>		



GENERAL
 1. DO NOT SCALE THIS DRAWING. ALL DIMENSIONS ARE IN METRES UNLESS OTHERWISE NOTED. ANY DISCREPANCIES ARE TO BE RECORDED AND REPORTED TO THE ENGINEERS IMMEDIATELY.
 2. THIS DRAWING IS TO BE READ IN CONJUNCTION WITH ALL OTHER ENGINEERS AND ARCHITECTS DRAWINGS AND THE SPECIFICATION.
 3. ANY EXISTING DETAILS WHICH ARE SHOWN ON THIS DRAWING ARE FOR GUIDANCE ONLY AND ARE TO BE CHECKED ON SITE BY THE CONTRACTOR. ANY VARIATIONS ARE TO BE RECORDED AND REPORTED TO THE ENGINEER IMMEDIATELY.

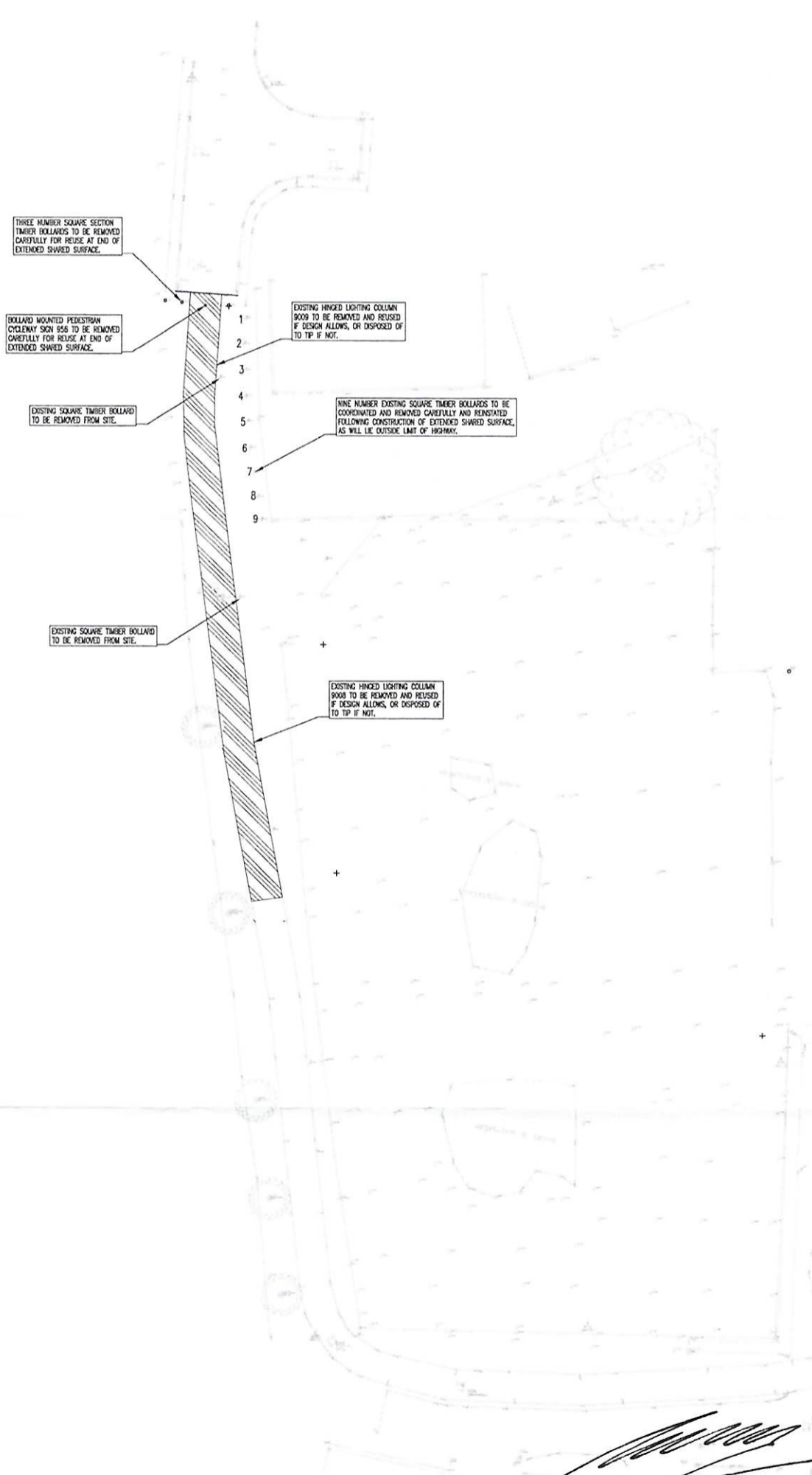

SITE CLEARANCE KEY
 EXISTING ADOPTED CYCLEWAY TO BE BROKEN OUT AND REMOVED TO VIRGIN FORMATION

Revision Notes		Date	Drawn
INGENT			
CONSULTING ENGINEERS			
Unit 10 Brightwell Barns, Waldringfield Road, Brightwell, Suffolk, IP10 0BJ Tel: 01473 558038 — www.ingent.co.uk — email: info@ingent.co.uk			
PRELIMINARY			
Project: STATION TERRACE, FRAMLINGHAM			
Drawing Title: SITE CLEARANCE PLAN			
Client: BENNETT HOMES		Date: DEC 22	
Drawn: JS	Designed: JS	Checked: RGW	Approved: RGW
Scale: 1:250			
Project No: 2210-754		Drawing No & Revision: 005	
		Size: A1	

[Handwritten signatures]



GENERAL
 1. DO NOT SCALE THIS DRAWING. ALL DIMENSIONS ARE IN METRES UNLESS OTHERWISE NOTED. ANY DISCREPANCIES ARE TO BE RECORDED AND REPORTED TO THE ENGINEERS IMMEDIATELY.
 2. THIS DRAWING IS TO BE READ IN CONJUNCTION WITH ALL OTHER ENGINEERS AND ARCHITECTS DRAWINGS AND THE SPECIFICATION.
 3. ANY EXISTING DETAILS WHICH ARE SHOWN ON THIS DRAWING ARE FOR GUIDANCE ONLY AND ARE TO BE CHECKED ON SITE BY THE CONTRACTOR. ANY VARIATIONS ARE TO BE RECORDED AND REPORTED TO THE ENGINEER IMMEDIATELY.

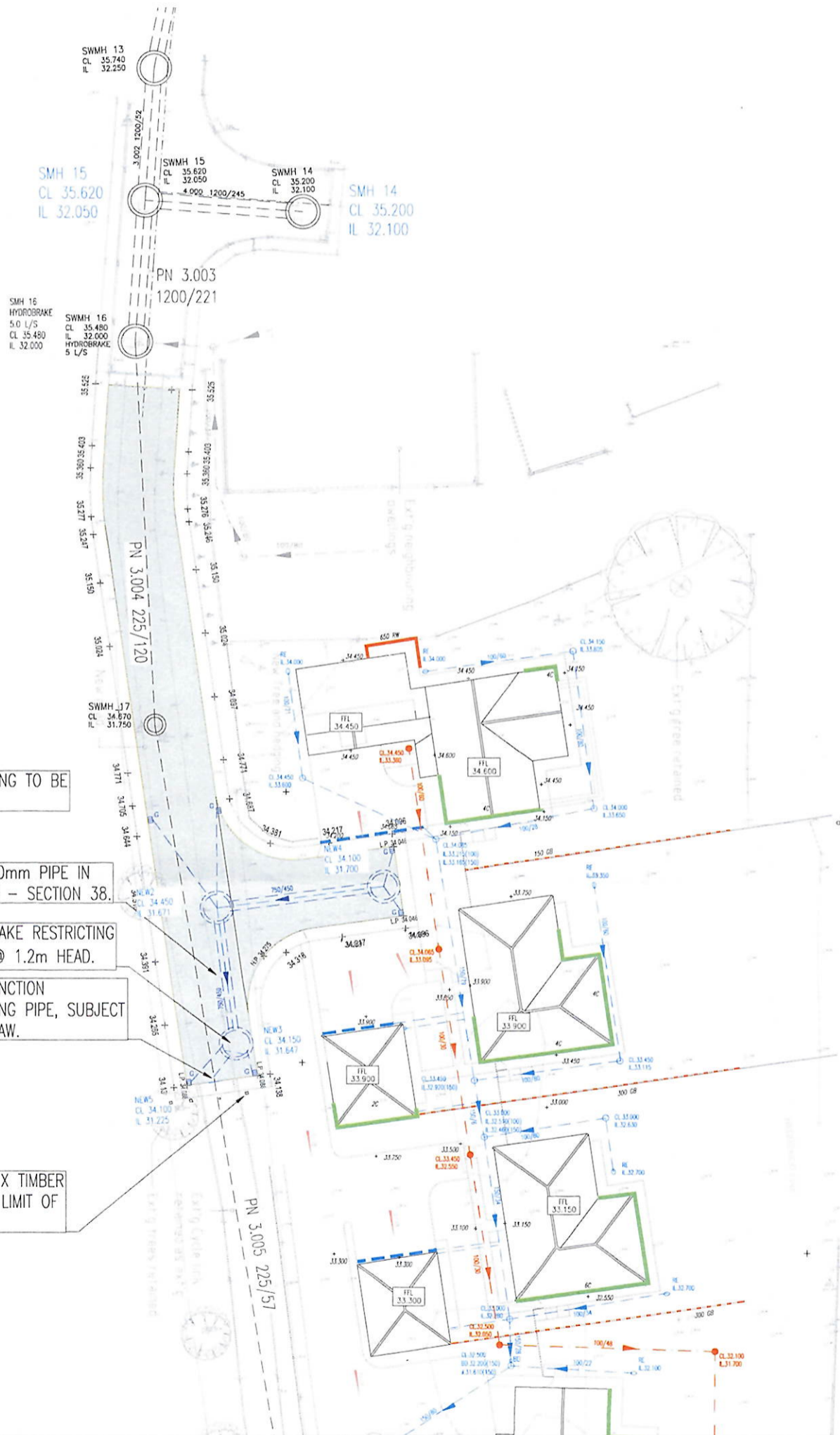

PROPOSED STREET LIGHTING TO BE CONFIRMED BY SCC.

NEW SECTION OF 24m OF 750mm PIPE IN 1800mm DIAMETER CHAMBERS - SECTION 38.

100mm ORIFICE HYDROBRAKE RESTRICTING DESIGN FLOW TO 2 L/s @ 1.2m HEAD.

NEW 225mm DIAMETER JUNCTION CONNECTION ON TO EXISTING PIPE, SUBJECT TO S106 CONSENT FROM AW.

BOLLARD AND SIGN 956, AND 3 X TIMBER BOLLARDS TO BE RELOCATED AT LIMIT OF HIGHWAY AS BEFORE.

REGRADE KEY	
RETAINING WALL - LEVEL RETAINED (MM)	450 RW
SCREEN WALL - LEVEL RETAINED (MM)	450 SW
SCREEN WALL - NO RETAINING	-----
GRAVEL BOARDS - LEVEL RETAINED (MM)	300 GB
UNDERBUILD WITH NO OF BRICK COURSES	2C
RAISED / SECONDARY D.P.C. (2 COURSES)	2PC
TANKING - WITH NO OF BRICK COURSES	2C
PROPOSED LEVEL	0.000
EXISTING LEVEL	0.000
GRADIENT	0.000
STEPS	0.000
BANKING MARKER	0.000
LEVEL THRESHOLD & PART M PLATFORM	0.000
FINISHED FLOOR LEVEL	FFL 00.000

Technical Specification	Head (m)	Flow (l/s)
Control Point	1.200	2.000
Primary Design	0.282	1.763
Flush Flow	0.573	1.432
Mean Flow	1.633	1.633

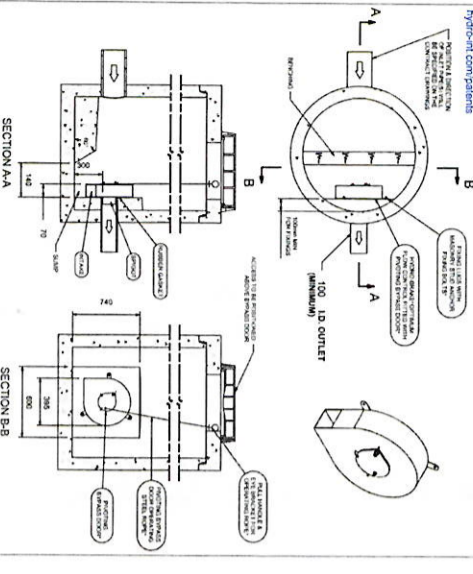

Hydro-Brake Optimum flow control including:
 1. 1mm gaps, 20% stainless steel
 2. 100% stainless steel
 3. 100% stainless steel
 4. 100% stainless steel
 5. 100% stainless steel
 6. 100% stainless steel
 7. 100% stainless steel
 8. 100% stainless steel
 9. 100% stainless steel
 10. 100% stainless steel

THIS DESIGN LAYOUT IS FOR ILLUSTRATIVE PURPOSES ONLY. NOT TO SCALE.

DESIGN: SHE-0064-2000-1200-2000
 DATE: 25/10/2023 14:41
 SITE: Station Terrace
 DESIGNER: Richard Wignall
 REF: 2210-754

Hydro-Brake Optimum
 International
 Hydro-Brake Optimum

Technical Specification	Head (m)	Flow (l/s)
Control Point	1.200	2.000
Primary Design	0.282	1.763
Flush Flow	0.573	1.432
Mean Flow	1.633	1.633

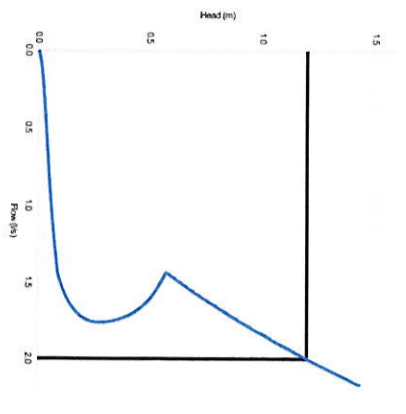

Head (m)	Flow (l/s)
0.000	0.000
0.041	0.604
0.083	1.263
0.124	1.594
0.166	1.693
0.207	1.725
0.248	1.758
0.290	1.763
0.331	1.755
0.372	1.739
0.414	1.715
0.455	1.677
0.497	1.621
0.538	1.556
0.579	1.439
0.621	1.484
0.662	1.528
0.703	1.570
0.745	1.611
0.786	1.650
0.828	1.689
0.869	1.726
0.910	1.763
0.952	1.799
0.993	1.834
1.034	1.868
1.076	1.901
1.117	1.924
1.159	1.966
1.200	1.999

DESIGN: SHE-0064-2000-1200-2000
 DATE: 25/10/2023 14:41
 SITE: Station Terrace
 DESIGNER: Richard Wignall
 REF: 2210-754

Hydro-Brake Optimum
 International
 Hydro-Brake Optimum

HYDROBRAKE INFORMATION

HYDROBRAKE NEWS
 RESTRICTION 2.0 l/s
 DESIGN HEAD 1.2m
 HYDRO BRAKE REFERENCE: CL-SHE-0064-2000-1200-2000

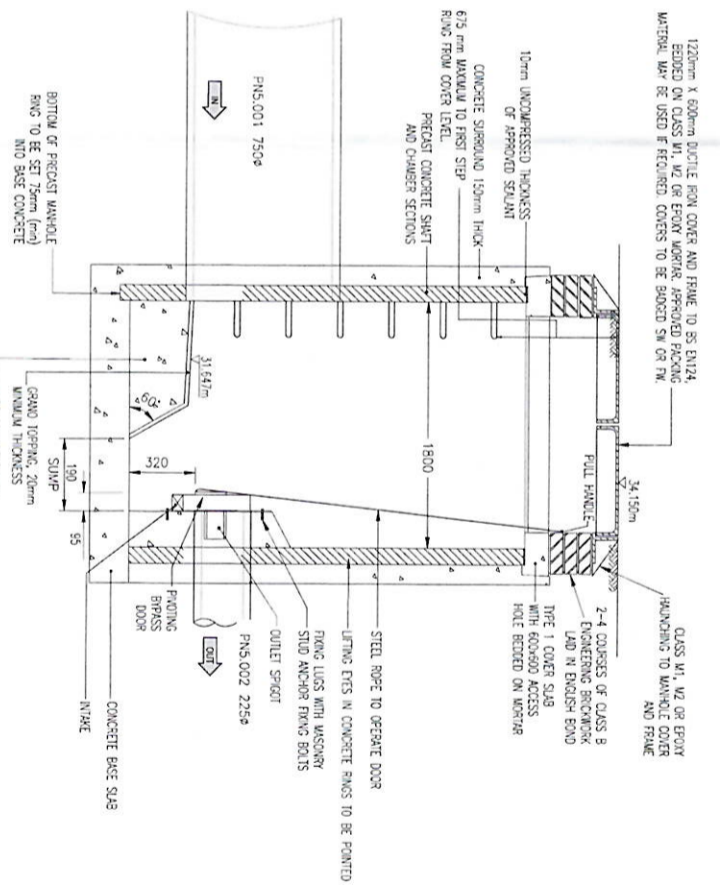

SECTION THROUGH HYDROBRAKE NEWS

SCALE 1:20

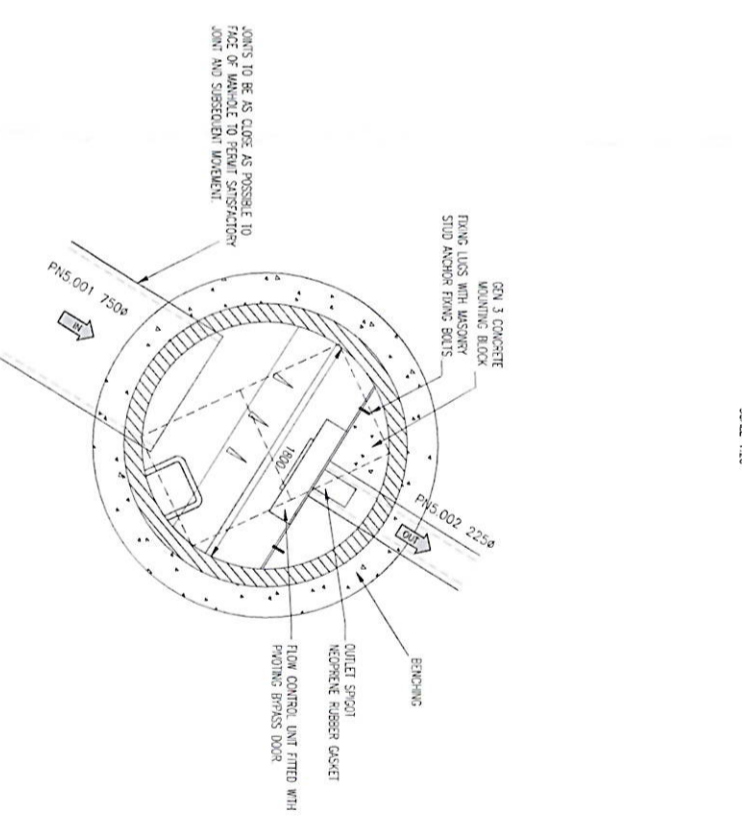

1. DO NOT SCALE THIS DRAWING. ALL DIMENSIONS ARE IN METRES UNLESS OTHERWISE NOTED. ANY DISCREPANCIES ARE TO BE RECORDED AND REPORTED TO THE ENGINEER IMMEDIATELY.
2. THIS DRAWING IS TO BE READ IN CONJUNCTION WITH ALL OTHER ENGINEERS AND ARCHITECTS DRAWINGS AND THE SPECIFICATION.
3. ANY EXISTING DETAILS WHICH ARE SHOWN ON THIS DRAWING ARE FOR GUIDANCE ONLY AND ARE TO BE CHECKED ON SITE BY THE CONTRACTOR. ANY VARIATIONS ARE TO BE RECORDED AND REPORTED TO THE ENGINEER IMMEDIATELY.

ADAPTABLE DRAINAGE

MANHOLES AND PREPWORK TO BE ADOPTED BY SUFFOLK COUNTY COUNCIL SHOULD BE CONSTRUCTED IN ACCORDANCE WITH THE REQUIREMENTS OF 'SENTRAGE' SECTOR GUIDANCE APPENDIX C' - DESIGN AND CONSTRUCTION GUIDANCE.

INGENT
 CONSULTING ENGINEERS
 Unit 10 Bighway Barn, Waterford Road, Suffolk, Suffolk, IP10 0BJ
 Tel: 01473 550338 www.ingent.co.uk email: info@ingent.co.uk

Worsafe SJTP
 CONSULTANT
 www.worsafe.co.uk

COMS
 SHED 1000000

PRELIMINARY

Project: STATION TERRACE FRAMLINGHAM

Drawing Title: S218 ADAPTABLE FLOW CONTROL CONSTRUCTION DETAILS

Client:	BENNETT HOMES	Date:	DEC 2022
Drawn:	JS	Checked:	RGW
Designed:	JS	Approved:	RGW

Scale: As Shown

Project No: 2210-754 Drawing No & Revision: 007A Size: A1

GENERAL
 1. DO NOT SCALE THIS DRAWING. ALL DIMENSIONS ARE IN METRES UNLESS OTHERWISE NOTED. ANY DISCREPANCIES ARE TO BE RECORDED AND REPORTED TO THE ENGINEERS IMMEDIATELY.
 2. THIS DRAWING IS TO BE READ IN CONJUNCTION WITH ALL OTHER ENGINEERS AND ARCHITECTS DRAWINGS AND THE SPECIFICATION.
 3. ANY EXISTING DETAILS WHICH ARE SHOWN ON THIS DRAWING ARE FOR GUIDANCE ONLY AND ARE TO BE CHECKED ON SITE BY THE CONTRACTOR. ANY VARIATIONS ARE TO BE RECORDED AND REPORTED TO THE ENGINEER IMMEDIATELY.

750Ø 1/451 L=13.09 PN=5.000 750Ø 1/450 L=10.80 PN=5.001 225Ø 1/8 L=3.17 PN=5.002

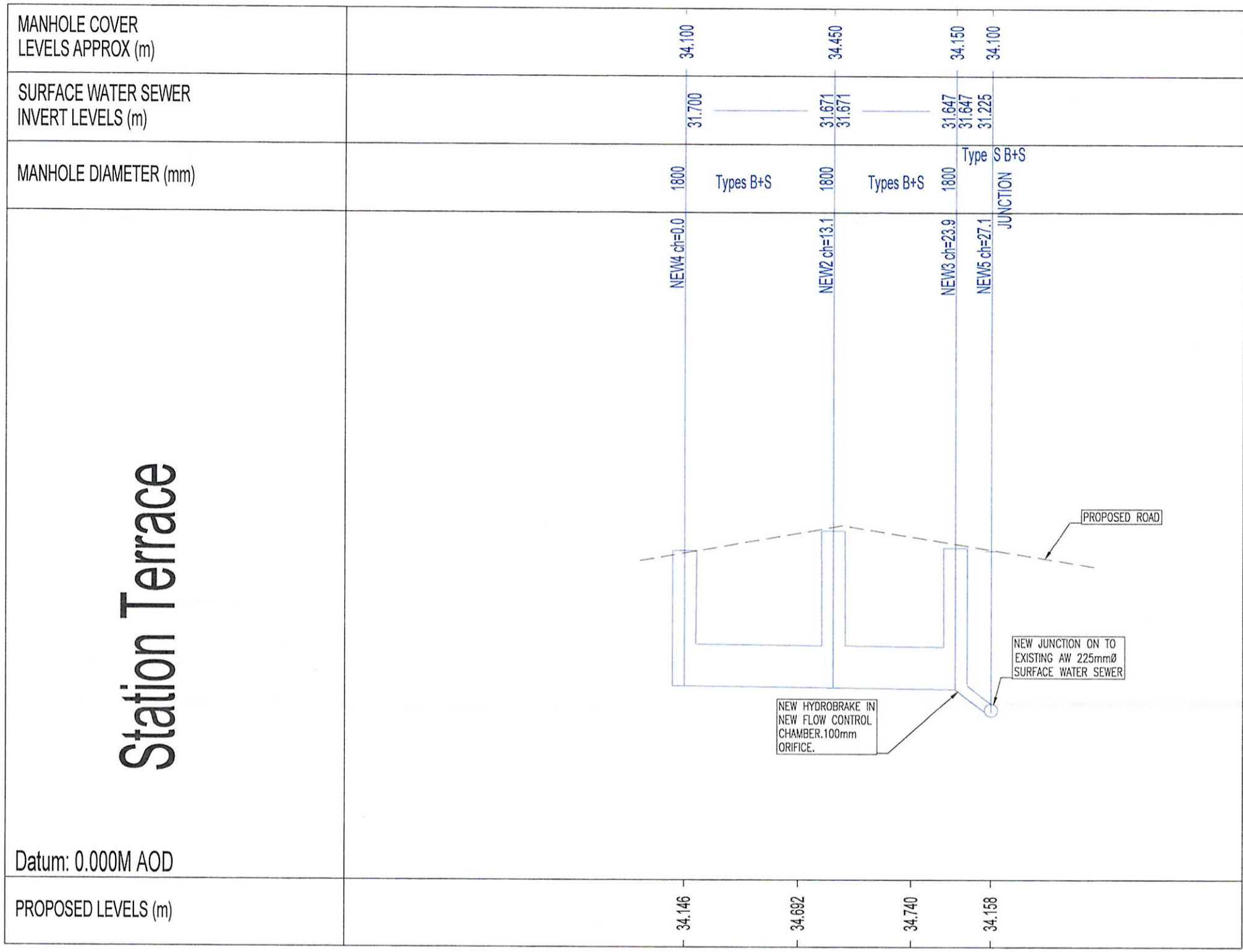

Station Terrace

Datum: 0.000M AOD

MH No.	MANHOLE DIM (mm)	MANHOLE TYPE	COVER LEVEL (m)	INVERT LEVEL (m)	EASTING (m)	NORTHING (m)	COVER TYPE
NEW4	1800mm	DCC TYPE B	34.100	31.700	628362.462	262917.621	BSEN124 D400
NEW2	1800mm	DCC TYPE B	34.450	31.671	628349.483	262915.898	BSEN124 D400
NEW3	1800mm	DCC TYPE B	34.150	31.647	628350.934	262905.227	BSEN124 D400
NEW5	JUNCTION			31.225	628349.206	262902.570	

[Handwritten signatures]

A ROAD DRAINAGE WITHIN 5M		Rev	Rev	25.11.23
Revision Notes		Rev	Rev	Date
INGENT CONSULTING ENGINEERS				
Unit 10 Brightwell Barns, Waldringfield Road, Brightwell, Suffolk, IP10 6BJ Tel: 01473 598038 — www.ingent.co.uk — email: info@ingent.co.uk				
worksafe consultant		SSIP		COMS
PRELIMINARY				
Project: STATION TERRACE, FRAMLINGHAM				
Drawing Title: SECTION 278 LONGSECTION AND SCHEDULE				
Client: BENNETT HOMES		Date: DEC 2022		
Drawn: JS	Designed: JS	Checked: RGW	Approved: RGW	
Scale: As Shown				
Project No: 2210-754	Drawing No & Revision: 008A	Size: A1		

GENERAL
 1. DO NOT SCALE THIS DRAWING. ALL DIMENSIONS ARE IN METRES UNLESS OTHERWISE NOTED. ANY DISCREPANCIES ARE TO BE RECORDED AND REPORTED TO THE ENGINEER IMMEDIATELY.
 2. THIS DRAWING IS TO BE READ IN CONJUNCTION WITH ALL OTHER ENGINEERS AND ARCHITECTS DRAWINGS AND THE SPECIFICATION.
 3. ANY EXISTING DETAILS WHICH ARE SHOWN ON THIS DRAWING ARE FOR GUIDANCE ONLY AND ARE TO BE CHECKED ON SITE BY THE CONTRACTOR. ANY VARIATIONS ARE TO BE RECORDED AND REPORTED TO THE ENGINEER IMMEDIATELY.

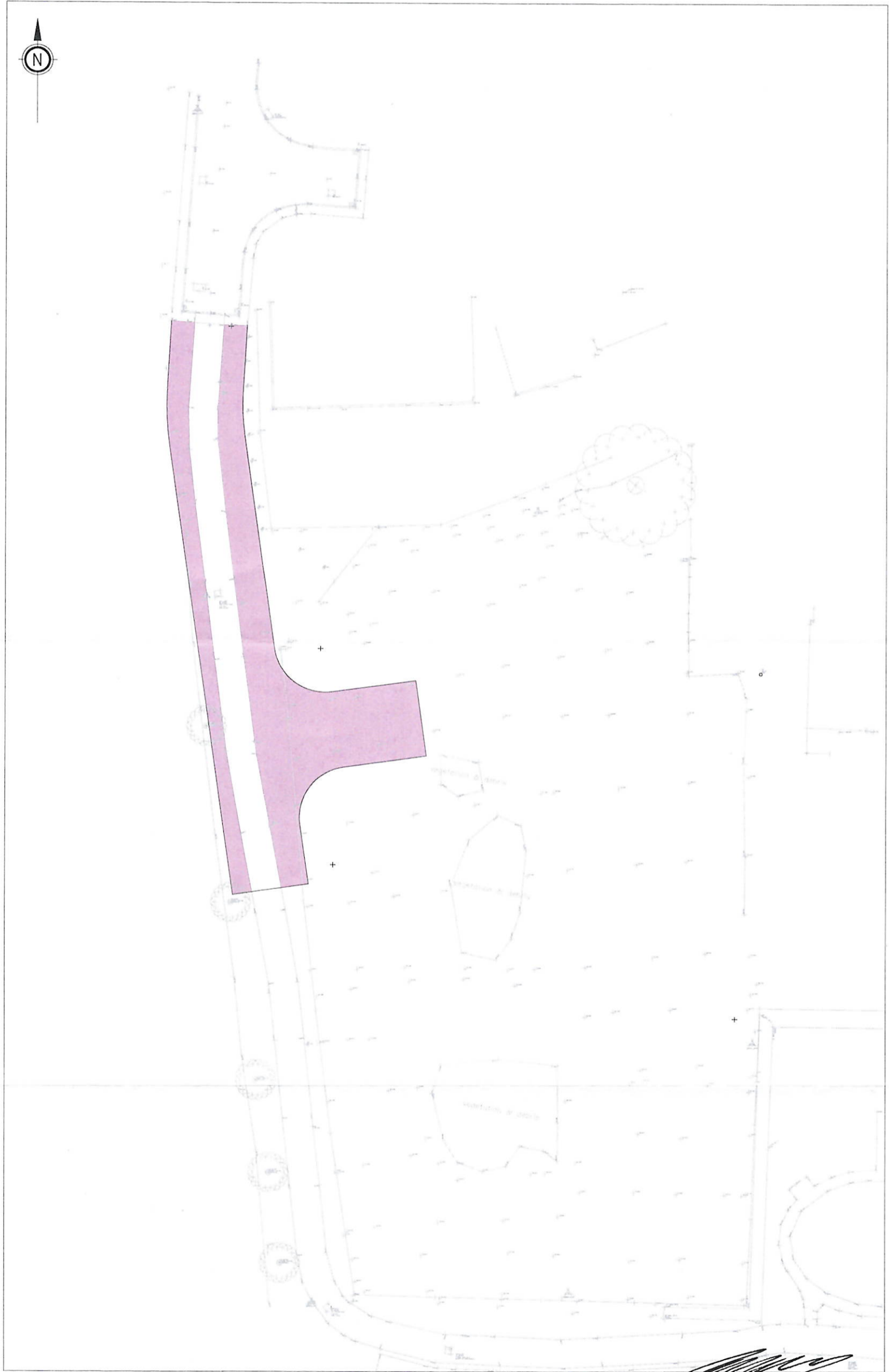

SITE CLEARANCE KEY
 DEVELOPER'S LAND TO BE DEDICATED AS HIGHWAY
 365 m²

[Handwritten signatures]

AMENDED TO SIC DRAWINGS		JS	1/11	23/05/23
Revision notes		Drawn	Approved	Date
INGENT CONSULTING ENGINEERS				
Unit 10 Brightwell Barns, Walkringfield Road, Brightwell, Suffolk, IP10 0BJ Tel: 01473 595038 — www.ingent.co.uk — email: info@ingent.co.uk				
worksafe consultant		SSIP		COMS
PRELIMINARY				
Project: STATION TERRACE, FRAMLINGHAM				
Drawing Title: LAND TO BE DEDICATED AS HIGHWAY PLAN				
Client: BENNETT HOMES		Date: DEC 22		
Drawn: JS	Designed: JS	Checked: RGW	Approved: RGW	
Scale: 1:200				
Project No: 2210-754	Drawing No & Revision: 277A		Size: A1	

GENERAL
 1. DO NOT SCALE THIS DRAWING. ALL DIMENSIONS ARE IN METRES UNLESS OTHERWISE NOTED. ANY DISCREPANCIES ARE TO BE RECORDED AND REPORTED TO THE ENGINEERS IMMEDIATELY.
 2. THIS DRAWING IS TO BE READ IN CONJUNCTION WITH ALL OTHER ENGINEERS AND ARCHITECTS DRAWINGS AND THE SPECIFICATION.
 3. ANY EXISTING DETAILS WHICH ARE SHOWN ON THIS DRAWING ARE FOR GUIDANCE ONLY AND ARE TO BE CHECKED ON SITE BY THE CONTRACTOR. ANY VARIATIONS ARE TO BE RECORDED AND REPORTED TO THE ENGINEER IMMEDIATELY.

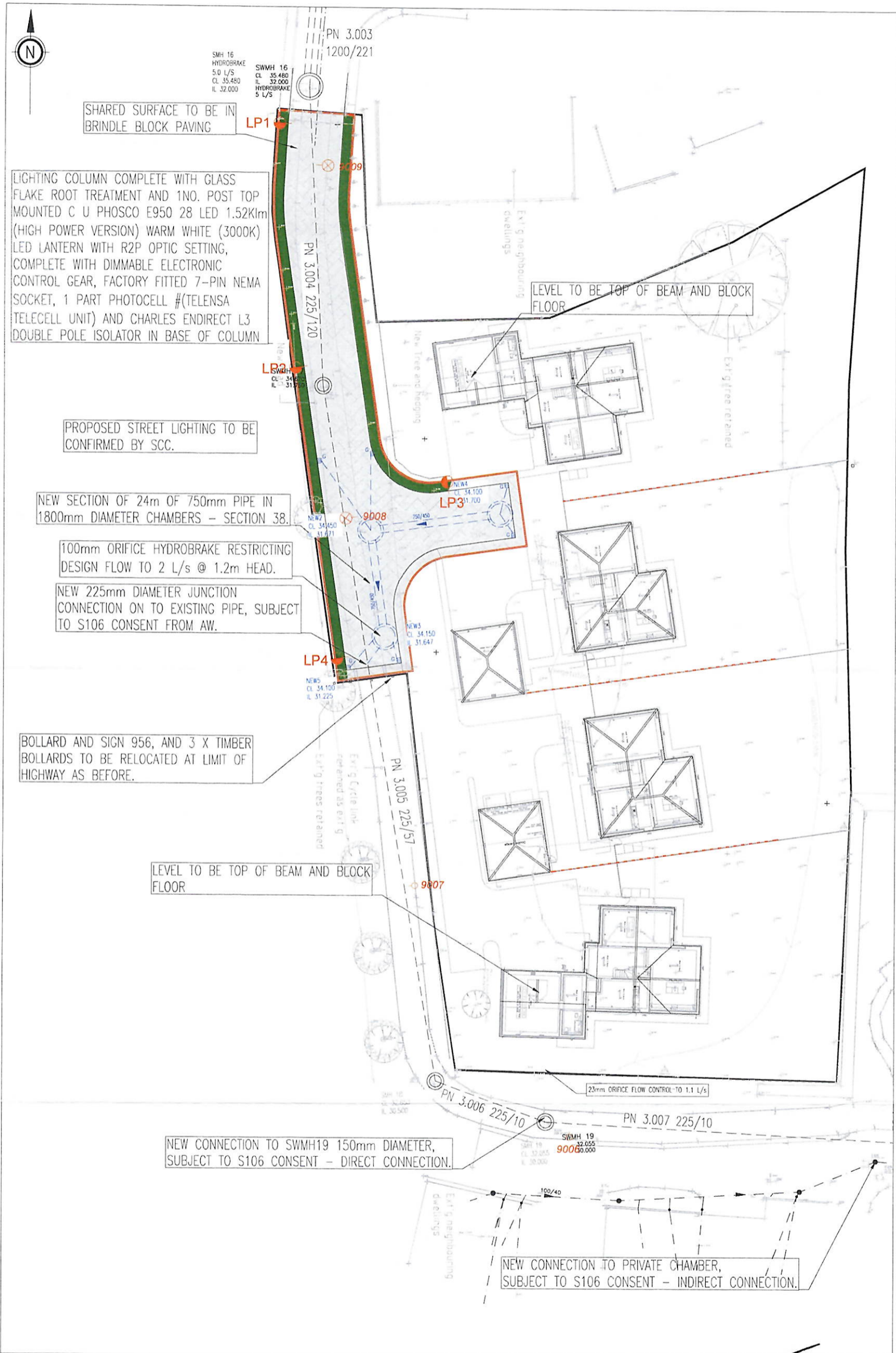

STREET LIGHTING NOTES:

1. ALL NEW STREET LIGHTING COLUMNS ARE TO BE INSTALLED WITHIN THE REAR OF THE FOOTPATH OR WITHIN THE REAR SERVICE STRIP UNLESS OTHERWISE INDICATED. WHERE COLUMNS ARE TO BE INSTALLED WITHIN SERVICE STRIPS, IT IS STRONGLY ADVISED THAT THE POSITIONS OF THE PROPOSED LIGHTING COLUMNS ARE MARKED AT AN EARLY STAGE USING STAKES OR PIPING OF A SIMILAR TO THAT OF THE LIGHTING COLUMN BASE, SO AS TO ENSURE ADEQUATE SPACE FOR THE LIGHTING COLUMNS TO BE INSTALLED WHILST NOT BEING BLOCKED/IMPEDED ON BY OTHER SERVICES. INSTALLATION OF COLUMNS OUTSIDE OF SERVICES STRIPS WILL NOT BE ACCEPTED.
2. WHERE ROAD LIGHTING COLUMNS ARE TO BE INSTALLED IN VERGE THEY SHALL BE SET BACK FROM THE EDGE OF THE KERB/ROAD SURFACE SO THAT THE REAR OF THE COLUMN IS 1.0m BACK FROM THE KERB EDGE UNLESS OTHERWISE INDICATED. WHERE A LIGHTING COLUMN IS INSTALLED IN AN AREA WHERE THE SERVICE STRIP IS INDICATED AS BEING ONLY 0.5m WIDE, AN AREA OF LAND 1m x 1m SURROUNDING THE BASE OF THE LIGHTING COLUMN WILL NEED TO BE DEDICATED AS HIGHWAY THEREFORE WIDENING THE SERVICE STRIP AROUND THE COLUMN.
3. ALL NEW STREET LIGHTING COLUMNS AND ILLUMINATED SIGNS ARE TO HAVE DNO STATUTORY MAINS ELECTRICITY SUPPLIES UNLESS OTHERWISE INDICATED.
4. NO TREES ARE TO BE PLANTED WITHIN 5m OF ANY NEW STREET LIGHTING COLUMNS TO ENSURE BLOCKING EFFECT ON LIGHTING UNITS IS MINIMISED.
5. IF NO LIGHTING COLUMNS HAVE BEEN PLANTED WITHIN 18 MONTHS OF THIS LIGHTING DESIGN BEING APPROVED, THE DESIGN SHOULD BE RE-SUBMITTED TO SCC'S STREET LIGHTING DEPARTMENT FOR RE-CHECKING/RE-APPROVAL.
6. NO CHANGES TO THE POSITIONS OR SPECIFICATION OF ANY LIGHTING EQUIPMENT SHOWN ON THIS APPROVED STREET LIGHTING DRAWING SHOULD BE MADE WITHOUT PRIOR AUTHORISATION FROM THE APPROVING SCC OFFICER MR NEIL EVANS OR IN THE APPROVING OFFICERS ABSENCE, THE SCC STREET LIGHTING MANAGER MR RICHARD WEBSTER.

STREET LIGHTING LEGEND:-

- EXISTING LIGHTING COLUMNS INSTALLED AS PART OF PREVIOUS PHASE OF S38 WORKS TO REMAIN
- EXISTING HINGED STREET LIGHTING COLUMNS TO BE DISCONNECTED AND CAREFULLY REMOVED. REDUNDANT COLUMNS AND LANTERNS TO BE RETURNED TO SUFFOLK COUNTY COUNCIL STORE FOR POSSIBLE FUTURE RE-USE.
- SUPPLY AND INSTALL NEW 6m GALVANIZED TUBULAR STEEL LIGHTING COLUMN COMPLETE WITH GLASS FLAKE ROOT TREATMENT AND 1NO. POST TOP MOUNTED C U PHOSCO E950 28LED 1.52Klm (HIGH POWER VERSION) WARM WHITE (3000K) LED LANTERN WITH R2P OPTIC SETTING. COMPLETE WITH DIMMABLE ELECTRONIC CONTROL GEAR, FACTORY FITTED 7-PIN NEMA SOCKET, 1-PART PHOTOCELL #TELENSA TELECELL UNIT) AND CHARLES ENDIRECT L3 DOUBLE POLE ISOLATOR IN BASE OF COLUMN.

NOTE: TELENSA TELECELLS AND SUFFOLK COUNTY COUNCIL IDENTIFICATION NUMBER PLATES ARE TO BE SUPPLIED AND INSTALLED ON ALL STREET LIGHTING LANTERNS AND ILLUMINATED SIGNS BY SCC'S INCUMBENT STREET LIGHTING CONTRACTOR, UPON ADOPTION, AT DEVELOPERS EXPENSE, (APPROXIMATELY £124 PER LIGHTING UNIT).

PLEASE ENSURE CORRECT LANTERNS ARE INSTALLED ON CORRECT COLUMNS AS PER SPECIFICATION ABOVE.
 A COPY OF THIS DRAWING IS TO BE ISSUED TO THE APPOINTED STREET LIGHTING CONTRACTOR AT ALL TIMES.

SCC SECTION 278 AGREEMENT KEY

DEVELOPERS OWNERSHIP BOUNDARY - BLACK	—
S278 LIMIT OF WORKS - RED	—
S38 BLOCK PAVING CARRIAGEWAY	▨
S278 GRASS VERGE - GREEN	▨
HIGHWAYS DRAINAGE - BLUE	PN 1.001 225/107
S104 ADOPTABLE SURFACE WATER - BLACK	PN 1.001 150/50
EXISTING SURFACE WATER - GREY	PN 1.001 150/50
SUPPLY AND INSTALL NEW 6m GALVANIZED TUBULAR STEEL LIGHTING COLUMN	○

2. CHECK FRANK AL BIRNBY	EW	25.01.23
3. STREET LIGHTING REVISIONS AND SCC COMMENTS	JS	25.01.23
4. AMENDED TO CLIENT'S COMMENTS	JS	27.04.23
5. HIGHWAY DRAINAGE INCLUDED IN SECTION 278	EW	25.01.23

INGENT CONSULTING ENGINEERS
 Unit 10 Brightwell Barns, Walsingham Road, Brightwell, Suffolk, IP10 0BJ.
 Tel: 01473 598038 — www.ingent.co.uk — email: info@ingent.co.uk

PRELIMINARY

Project: STATION TERRACE, FRAMLINGHAM			
Drawing Title: SECTION 278 GENERAL ARRANGEMENT			
Client: BENNETT HOMES		Date: NOV 22	
Drawn: JS	Designed: JS	Checked: RGW	Approved: RGW
Scale: 1:200		Project No & Revision: 278D	
Project No: 2210-754		Size: A1	